

**ASSP**

# Single Serial Input PLL Frequency Synthesizer

## On-Chip prescaler

### MB15C02

#### ■ DESCRIPTION

The Fujitsu MB15C02 is a serial input Phase Locked Loop (PLL) frequency synthesizer with a prescaler. A 64/65 division is available for the prescaler that enables pulse swallow operation.

This operates with a supply voltage of 1.0 V (min.).

MB15C02 is suitable for mobile communications, such as paging systems.

#### ■ FEATURES

- High frequency operation: 220 MHz max @ $V_{DD} = 1.0$  V to 1.5 V  
330 MHz max @ $V_{DD} = 1.2$  V to 1.5 V  
450 MHz max @ $V_{DD} = 1.3$  V to 1.5 V
- Single power supply :  $V_{DD} = 1.0$  to 1.5 V
- Power saving function
- Pulse swallow function: 64/65
- Serial input 14-bit programmable reference divider:  $R = 5$  to 16,383
- Serial input 18-bit programmable divider consisting of:
  - Binary 6-bit swallow counter: 0 to 63
  - Binary 12-bit programmable counter: 5 to 4,095
- Wide operating temperature:  $T_a = -20$  to  $60^{\circ}\text{C}$

#### ■ PACKAGES

16-pin, Plastic SSOP

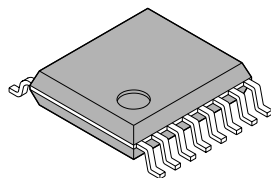

(FPT-16P-M05)

20-pin, Plastic SSOP

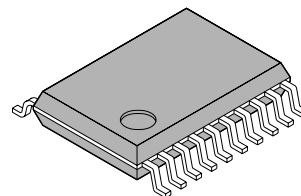

(FPT-20P-M03)

# MB15C02

## ■ PIN ASSIGNMENTS

### SSOP-20 pin

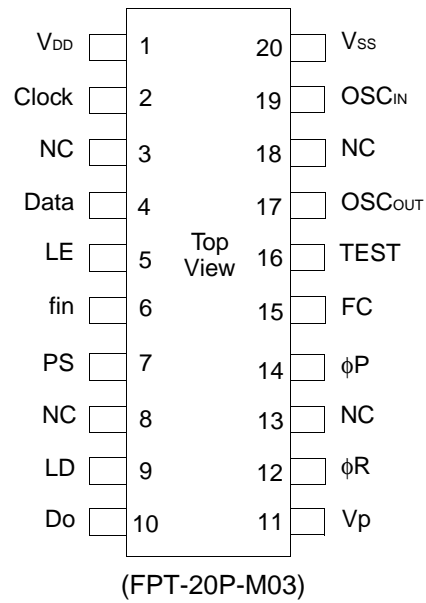

### SSOP-16 pin

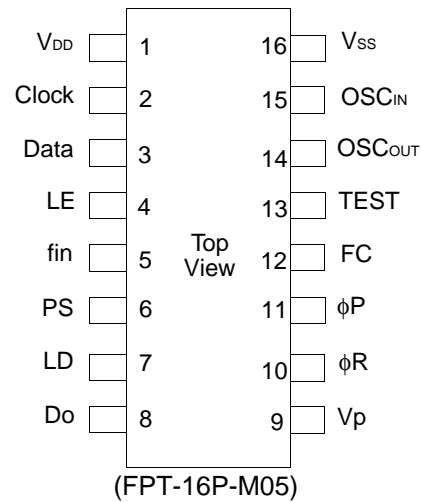

## ■ PIN DESCRIPTIONS

Pin no.		Pin name	I/O	Descriptions
SSOP 16	SSOP 20			
1	1	V <sub>DD</sub>	–	Power supply voltage
2	2	Clock	I	Clock input for the shift register.(Schmitt trigger input) Data is shifted into the shift register on the rising edge of the clock.
–	3	NC	–	No connection
3	4	Data	I	Serial data input using binary code.(Schmitt trigger input)
4	5	LE	I	Load enable signal input (Schmitt trigger input) When LE is high, the data in the shift register is transferred to a latch, according to the control bit in the serial data.
5	6	fin	I	Prescaler input. A bias circuit and amplifier are at input port. Connection with an external VCO should be done by AC coupling.
6	7	PS	I	Power saving mode control. This pin must be set at “L” at Power-ON. PS = “H” ; Normal mode PS = “L” ; Power saving mode
–	8	NC	–	No connection
7	9	LD	O	Lock detector signal output. When a PLL is locking, LD outputs “H”. When a PLL is not locking, LD outputs “L”.
8	10	Do	O	Charge pump output. Phase of the charge pump can be reversed by FC input. The Do output may be inverted by FC input. The relationships between the programmable reference divider output (fr) and the programmable divider output (fp) are shown below; fr > fp : “H” level (FC = “L”), “L” level (FC = “H”) fr = fp : High impedance fr < fp : “L” level (FC = “L”), “H” level (FC = “H”)
9	11	Vp	–	Power supply for the charge pump.
10	12	φR	O	Phase comparator output pin (for external charge pump). Relation between the programmable reference divider output (fr) and the programmable divider output (fp) are shown below; When FC = “L” fr > fp : φR = “L” level, φP = “L” level fr = fp : φR = “L” level, φP = High impedance fr < fp : φR = “H” level, φP = High impedance When FC = “H” fr > fp : φR = “H” level, φP = High impedance fr = fp : φR = “L” level, φP = High impedance fr < fp : φR = “L” level, φP = “L” level
–	13	NC	–	No connection
11	14	φP	O	Phase comparator output pin (for external charge pump). Refer to Pin description for φR. φP pin is a Nch open drain output.
12	15	FC	I	Phase comparator input select pin.
13	16	TEST	I	Test mode select pin. (Pull down resistor) Please set this pin to ground or open usually.

(Continued)

# MB15C02

(Continued)

Pin no.		Pin name	I/O	Descriptions
SSOP 16	SSOP 20			
14	17	OSC <sub>OUT</sub>	O	Oscillator output. Connection for an external crystal.
–	18	NC	–	No connection
15	19	OSC <sub>IN</sub>	I	Programmable reference divider input. Oscillator input. Clock can be input to OSC <sub>IN</sub> from outside. In the case, please leave OSC <sub>OUT</sub> pin open and make connection with OSC <sub>IN</sub> as AC coupling.
16	20	V <sub>SS</sub>	–	Ground pin.

## ■ BLOCK DIAGRAM

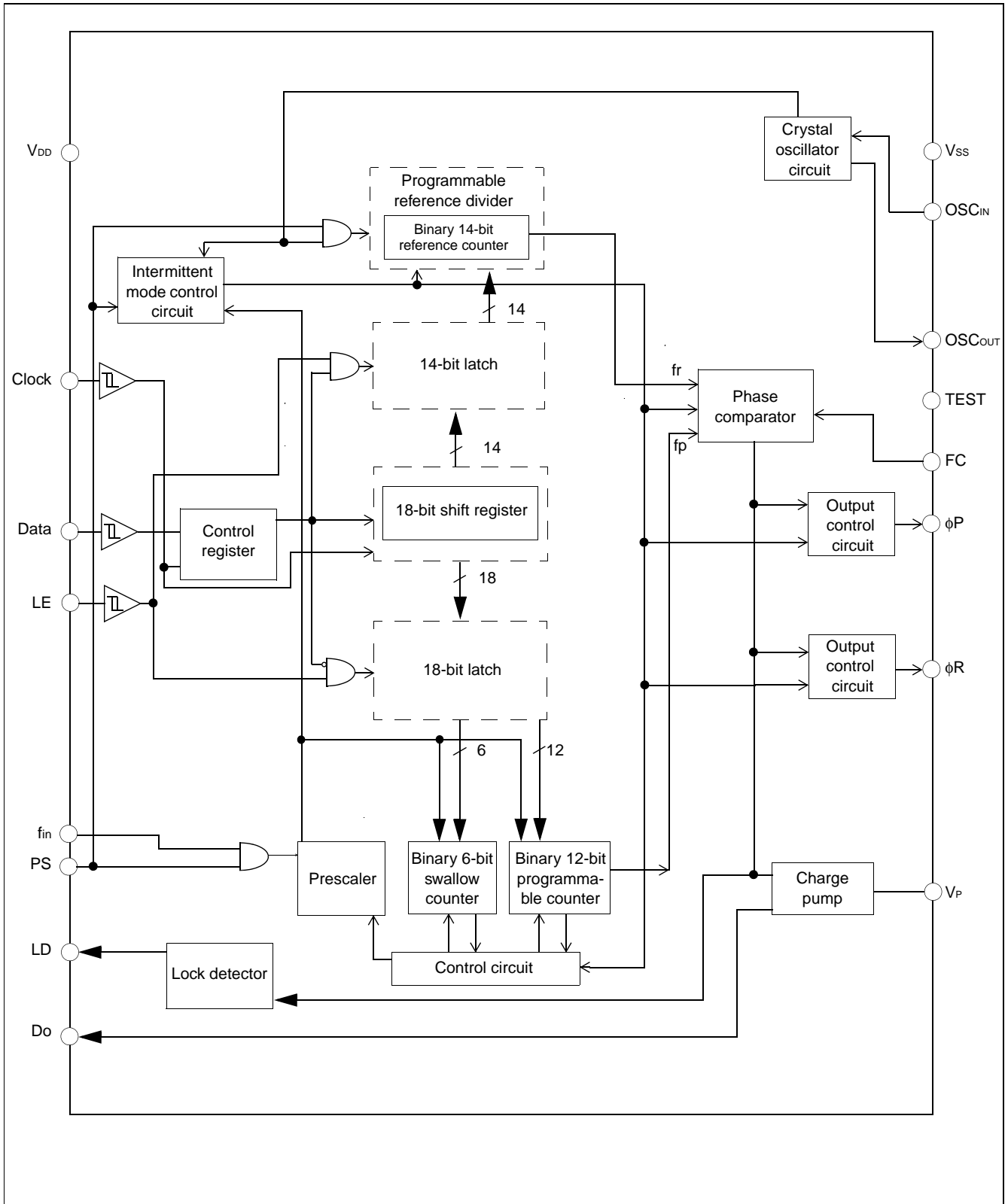

# MB15C02

## ■ ABSOLUTE MAXIMUM RATINGS

Parameter	Symbol	Rating		Unit	Remark
		Min.	Max.		
Power supply voltage	$V_{DD}, V_P$	GND-0.5	+2.0	V	
Input voltage	$V_{IN}$	GND-0.5	$V_{DD} + 0.5$	V	
Output voltage	$V_{OUT}$	GND-0.5	$V_{DD} + 0.5$	V	
Output current	$I_{OUT}$	-10	+10	mA	
Storage temperature	$T_{stg}$	-40	+125	°C	

**WARNING:** Semiconductor devices can be permanently damaged by application of stress (voltage, current, temperature, etc.) in excess of absolute maximum ratings. Do not exceed these ratings.

## ■ RECOMMENDED OPERATING CONDITIONS

Parameter	Symbol	Value			Unit	Remark	
		Min.	Typ.	Max.			
Power supply voltage	$V_{DD}, V_P$	1.0	-	1.5	V	For 220 MHz	$V_{DD} = V_P$
		1.2	-	1.5		For 330 MHz	
		1.3	-	1.5		For 450 MHz	
Input voltage	$V_{IN}$	GND	-	$V_{DD}$	V		
Operating temperature	$T_a$	-20	-	+60	°C		

**WARNING:** The recommended operating conditions are required in order to ensure the normal operation of the semiconductor device. All of the device's electrical characteristics are warranted when the device is operated within these ranges.

Always use semiconductor devices within their recommended operating condition ranges. Operation outside these ranges may adversely affect reliability and could result in device failure.

No warranty is made with respect to uses, operating conditions, or combinations not represented on the data sheet. Users considering application outside the listed conditions are advised to contact their FUJITSU representatives beforehand.

## ■ ELECTRICAL CHARACTERISTICS

(For 220 MHz :  $V_{DD} = V_p = 1.0$  to  $1.5$  V,  $T_a = -20$  to  $+60^\circ\text{C}$ )  
 (For 330 MHz :  $V_{DD} = V_p = 1.2$  to  $1.5$  V,  $T_a = -20$  to  $+60^\circ\text{C}$ )  
 (For 450 MHz :  $V_{DD} = V_p = 1.3$  to  $1.5$  V,  $T_a = -20$  to  $+60^\circ\text{C}$ )

Parameter		Symbol	Condition	Value			Unit	
				Min.	Typ. <sup>*3</sup>	Max. <sup>*4</sup>		
Power supply current	Active Mode	$I_{DD}^{*1}$	$(V_{DD}=1.0\text{V}/220\text{MHz})$	–	0.6	1.2	mA	
			$(V_{DD}=1.2\text{V}/330\text{MHz})$	–	1.0	1.8		
			$(V_{DD}=1.3\text{V}/450\text{MHz})$	–	1.3	2.2		
Power saving current	Power saving mode	$I_{DDS}^{*2}$	$(V_{DD}=1.0\text{V})$	–	50	250	$\mu\text{A}$	
			$(V_{DD}=1.2\text{V})$	–	70	300		
			$(V_{DD}=1.3\text{V})$	–	80	350		
Operating frequency	fin	fin	Programmable divider $(V_{DD}=1.0$ to $1.5\text{V})$	10	–	220	MHz	
			$(V_{DD}=1.2$ to $1.5\text{V})$	10	–	330		
			$(V_{DD}=1.3$ to $1.5\text{V})$	10	–	450		
	OSC <sub>IN</sub>	f <sub>OSC</sub>	Programmable reference divider	5	–	20	MHz	
Input sensitivity	fin		V <sub>fin</sub>	AC coupling	–2.0	–	–	dBm
	OSC <sub>IN</sub>		V <sub>OSC</sub>	AC coupling	–2.0	–	–	
Input voltage	Except for fin and OSC <sub>IN</sub>	H level	V <sub>IH</sub>	–	$V_{DD} - 0.2$	–	–	V
		L level	V <sub>IL</sub>	–	–	–	0.2	
Input current	Except for fin, OSC <sub>IN</sub> and TEST	H level	I <sub>IH</sub>	$V_{IN}=V_{DD}$	–	–	+1.0	$\mu\text{A}$
		L level	I <sub>IL</sub>	$V_{IN}=\text{GND}$	–1.0	–	–	
Output voltage	Except for OSC <sub>OUT</sub> and $\phi\text{P}$	H level	V <sub>OH</sub>	$I_{OH} = -0.2$ mA	$V_{DD} - 0.2$	–	–	V
		L level	V <sub>OL</sub>	$I_{OL} = 0.2$ mA	–	–	0.2	
	$\phi\text{P}$	L level	V <sub>OL</sub>	$I_{OL} = 0.2$ mA	–	–	0.2	V
High impedance cutoff current	Do		I <sub>OFF1</sub>	$V_{OUT} = \text{GND to } V_P$	–100	–	100	nA
	$\phi\text{P}$		I <sub>OFF2</sub>	$V_{OUT} = V_{DD}$	–	–	100	

\*1: Conditions; Inputs except for fin, OSC<sub>IN</sub> and TEST are grounded, Outputs are opened.  
 Specifying the current flowing in  $V_{DD}$  and  $V_p$  at operating state under conditions of  $V_{DD} = V_p$ , fin = 220 MHz, or 330 MHz, and OSC<sub>IN</sub> = 12.8 MHz.  
 The current at locking state shows  $I_{DD}$  Supply current (P.20).

\*2: Conditions; PS = Low, Inputs except for fin, OSC<sub>IN</sub> and TEST are grounded, Outputs are opened.

\*3: Condition;  $T_a = 25^\circ\text{C}$

\*4: Condition;  $T_a = -20$  to  $+60^\circ\text{C}$

## ■ FUNCTION DESCRIPTIONS

### 1. Pulse Swallow Function

The divide ratio can be calculated using the following equation:

$$f_{vco} = [(M \times N) + A] \times f_{osc} \div R \quad (A < N)$$

- $f_{vco}$  : Output frequency of external voltage controlled oscillator (VCO)
- $N$  : Preset divide ratio of binary 12-bit programmable counter (5 to 4,095)
- $A$  : Preset divide ratio of binary 6-bit swallow counter (0 to 63)
- $f_{osc}$  : Output frequency of the reference frequency oscillator
- $R$  : Preset divide ratio of binary 14-bit programmable reference counter (5 to 16,383)
- $M$  : Preset modulus of dual modulus prescaler (64)

### 2. Circuit Description

#### (1) Intermittent operation

The intermittent operation of the MB15C02 refers to the process of activating and deactivating its internal circuit thus saving power dissipation otherwise consumed by the circuit. If the circuit is simply restarted from the power saving state, however, the phase relation between the reference frequency ( $f_r$ ) and the programmable frequency ( $f_p$ ), which are the input to the phase comparator, is not stable even when they are of the same value. This may cause the phase comparator to generate an excessively large error signal, resulting in an out-of-synth lock frequency

To preclude the occurrence of this problem, the MB15C02 has an intermittent mode control circuit which forces the frequencies into phase with each other when the IC is reactivated, thus minimizing the error signal and resultant lock frequency fluctuations. The intermittent mode control circuit is controlled by the PS pin. Setting pin PS high provides the normal operation mode and setting the pin low provides the power saving mode. The MB15C02 behavior in the active and power saving modes is summarized below.

Active mode (PS = "H")

All MB15C02 circuits are active and provide the normal operation.

Power saving mode (PS = "L")

The MB15C02 stops any circuits that consume power heavily as well as cause little inconvenience when deactivated and enters the low-power dissipation state. Do,  $\phi R$ ,  $\phi P$ , and LD pins take the same state as when the PLL is locked. Do pin becomes a high-impedance state and the input voltage to the voltage control oscillator (VCO) is maintained at the same level as in active mode (that is, locked state) according to a time constant of a low pass filter (LPF). Consequently, the output frequency from the VCO ( $f_{vco}$ ) is maintained at approximately the lock frequency.

Applying the intermittent operation by alternating the active and power saving modes, and also forcing the phases of  $f_r$  and  $f_p$  to synchronize when it switches from stand by to active modes, the MB15C02 can keep the power dissipation of its entire circuitry to the minimum.

#### (2) Programmable divider

The  $f_{vco}$  input through fin pin is divided by the programmable divider and then output to the phase comparator as  $f_p$ . It consists of a dual modulus prescaler, a 6-bit binary swallow counter, a 12-bit binary programmable counter, and a controller which controls the divide ratio of the prescaler



Divide ratio range:

- Prescaler :  $M = 64, M+1=65$
- Swallow counter :  $A = 0$  to 63
- Programmable counter :  $N = 5$  to 4095

The MB15C02 uses the pulse swallow method; consequently, the divide ratios of the swallow and programmable counters must satisfy the relationship  $N > A$ .

The total divide ratio of the programmable divider is calculated as follows:  
 Total divide ratio =  $(M + 1) \times A + M \times (N - A) = M \times N + A = 64 \times N + A$

When  $N$  is set within  $5 \leq N \leq 63$ , the possible divide ratio  $A$  of the swallow counter can take values  $0 \leq A \leq N-1$  because  $N$  must be greater than  $A$ . For example,  $0 \leq A \leq 19$  is allowed when  $N=20$  but  $20 \leq A \leq 63$  is not allowed in that case. Consequently,  $N \geq 64$  must be satisfied for the total divider to be set within  $0 \leq A \leq 63$ .

The  $f_p$  and  $f_{in}$  have the following relation:  
 $f_p = f_{in} / (64 \times N + A)$

### (3) Programmable reference divider

The programmable reference divider divides the reference oscillation frequency ( $f_{osc}$ ) from the crystal oscillator connected between OSCin and OSCout pins or from the external oscillator input taken in directly through OSCin, pin and then, sends the resultant  $f_r$  to the phase comparator. It consists of a 14-bit binary programmable reference counter. When the output from the external oscillator is to be input directly to OSCin, pin the connection must be AC coupled and OSCout pin is left open. Also, to prevent OSCout from malfunctioning, its traces on the printed circuit board must be kept minimal or eliminated entirely; whenever possible, it must be free of any form of load.

The following divider is used:

Programmable reference counter :  $R = 5$  to 16383

The  $f_r$  and  $f_{osc}$  have the following relation:  
 $f_r = f_{osc} / R$

### (4) Phase comparator

The phase comparator detects the phase difference between the outputs  $f_r$  and  $f_p$  from the dividers and generates an error signal that is proportional to phase difference. The outputs from the phase comparator include 1) Do which takes on one of the three states, namely, "L" (low), "H" (high), and "Z" (high impedance), and is sent to the LPF, 2)  $\phi_R$ , 3)  $\phi_P$ , 4) LD which indicates the PLL lock or unlock states.

#### (a) Phase comparator

The phase comparator detects the phase error between  $f_r$  and  $f_p$ , then generates an error signal that is proportional to the phase error. The roles of the  $f_r$  and  $f_p$  supplied to the phase comparator may be reversed by switching the logical input level of pin FC. This inverts the logical level of the Do output. The logical level of Do output may be selected according to the characteristics of the external LPF and the VCO. (Refer to Table 1.)

**Table. 1 Phase comparator inputs/output relationships**

Phase relation \ Output	FC = "L"			FC = "H"		
	Do	$\phi_R$	$\phi_P$	Do	$\phi_R$	$\phi_P$
$f_r > f_p$	H	L	L	L	H	Z
$f_r = f_p$	Z	L	Z	Z	L	Z
$f_r < f_p$	L	H	Z	H	L	L

## (b) Charge pump

The charge pump is available in two forms: internal external.

Internal charge pump output (Do)

External charge pump outputs ( $\phi R$ ,  $\phi P$ )

## (c) Phase comparator input/output waveforms

The phase comparator outputs logic levels summarized in Table 1, according to the phase error between fr and fp. Note that  $\phi P$  is an Nch open drain output. The pulse width of the phase comparator outputs are identical and equal to the phase error between fr and fp as shown in Figure 1.

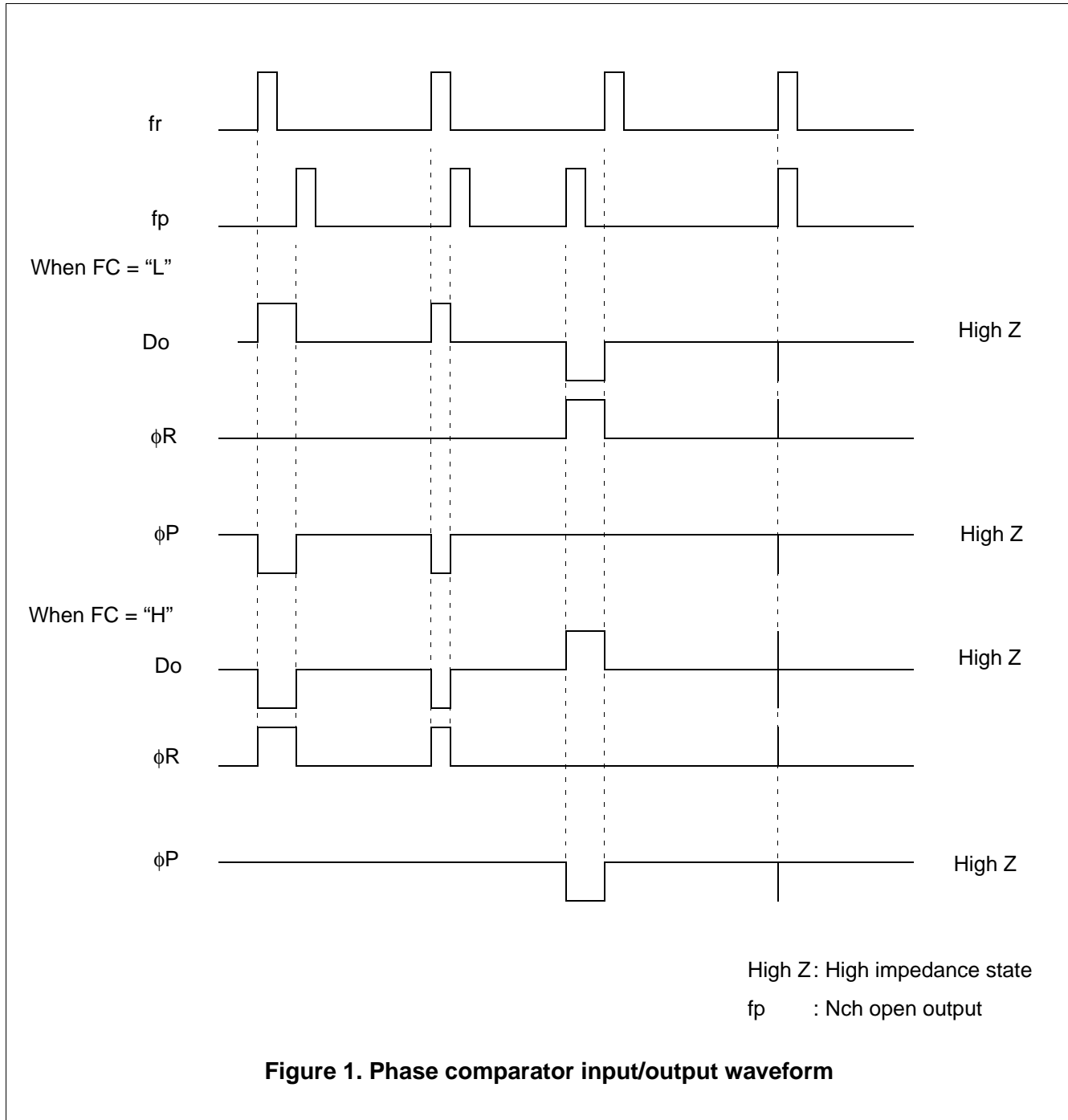

## (d) Lock detector

The lock detector detects the lock and unlock states of the PLL. The lock detector outputs “H” when the PLL enters the lock state and outputs “L” when the PLL enters the unlock state as shown in Figure 2. When PS = “L”, the lock detector outputs “H” compulsorily.

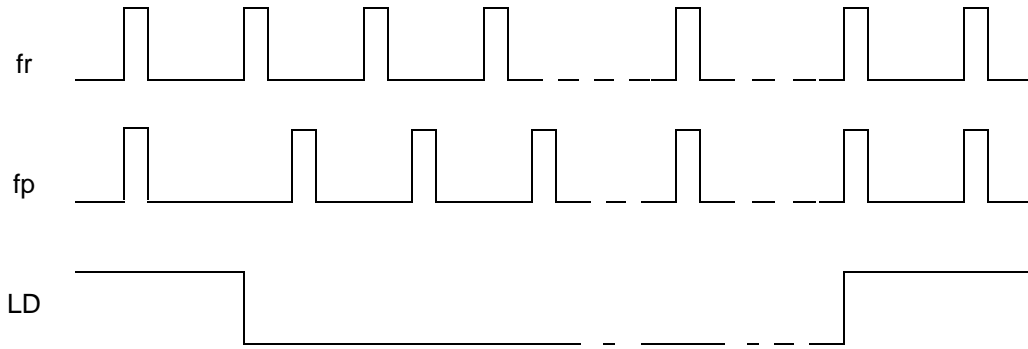
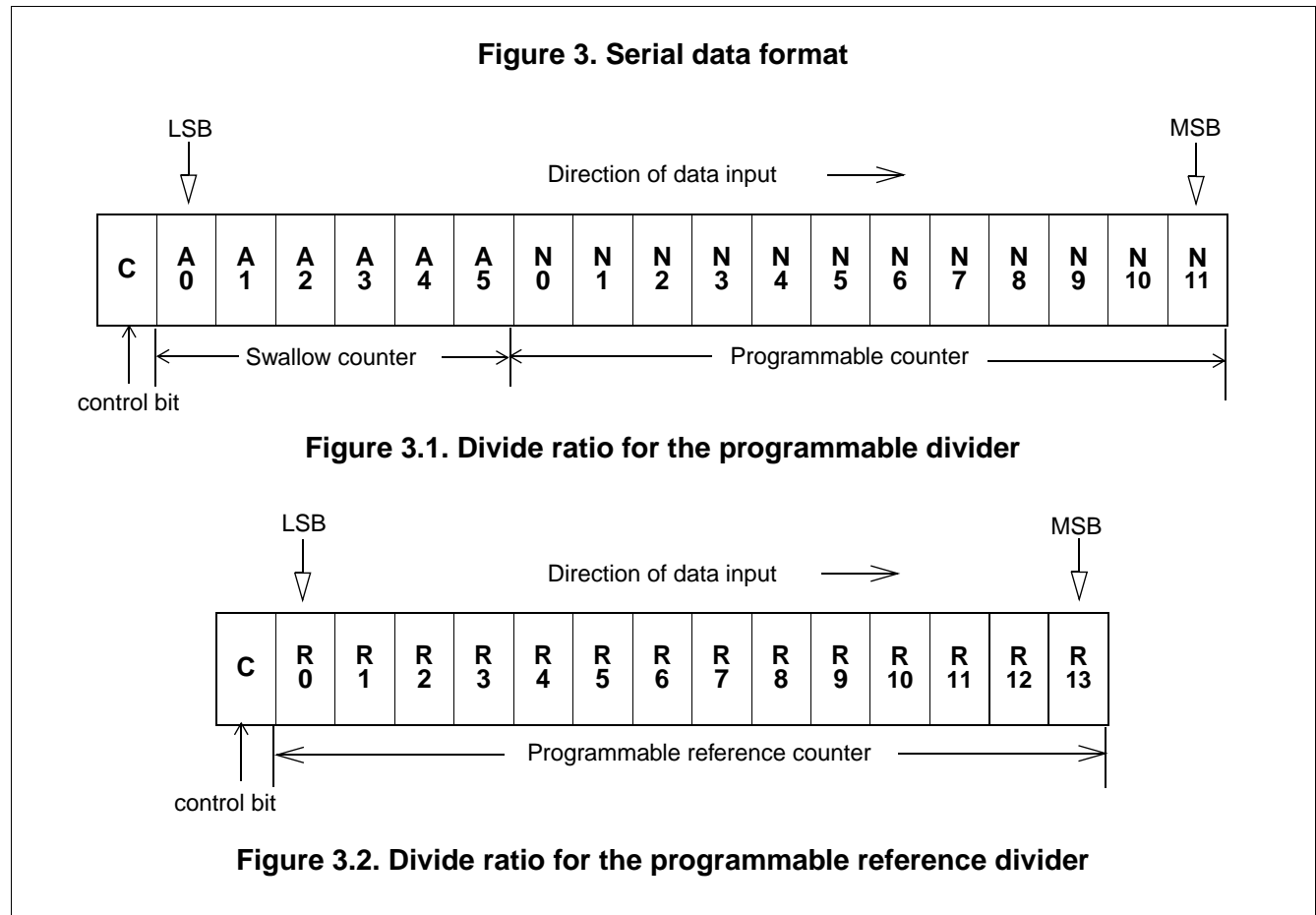

**Figure 2. Phase comparator input/output waveforms (Lock detector)**

## 4. Setting the Divide Ratio

### (1) Serial data format

The format of the serial data is shown in Figure 3. The serial data is composed of a control bit and divide ratio setting data. The control bit selects the programmable divider or programmable reference divider. In case of the programmable divider, serial data consists of 18 bits(6 bits for the swallow counter and 12 bits for the programmable counter) and 1 control bit as shown in Figure 3.1. In case of the programmable reference divider, the serial data consists of 14 divider bits and 1 control bit as shown in Figure 3.2. The control bit is set to 0 to identify the serial data for the programmable divider and to 1 to select the serial data for the programmable reference divider.



## (2) The flow of serial data

Serial data is received via data pin in synchronization with the clock input and loaded into shift register which contains the divide ratio setting data and into the control register which contains the control bit. The logical product (through the AND gate in Figure 4) of LE and the control register output (i.e., control bit) is fed to the enable input of the latches. Accordingly, when LE is set high, the latch for the divider identified by the control bit is enabled and the divide ratio data from the shift register is loaded into the selected counter (s).

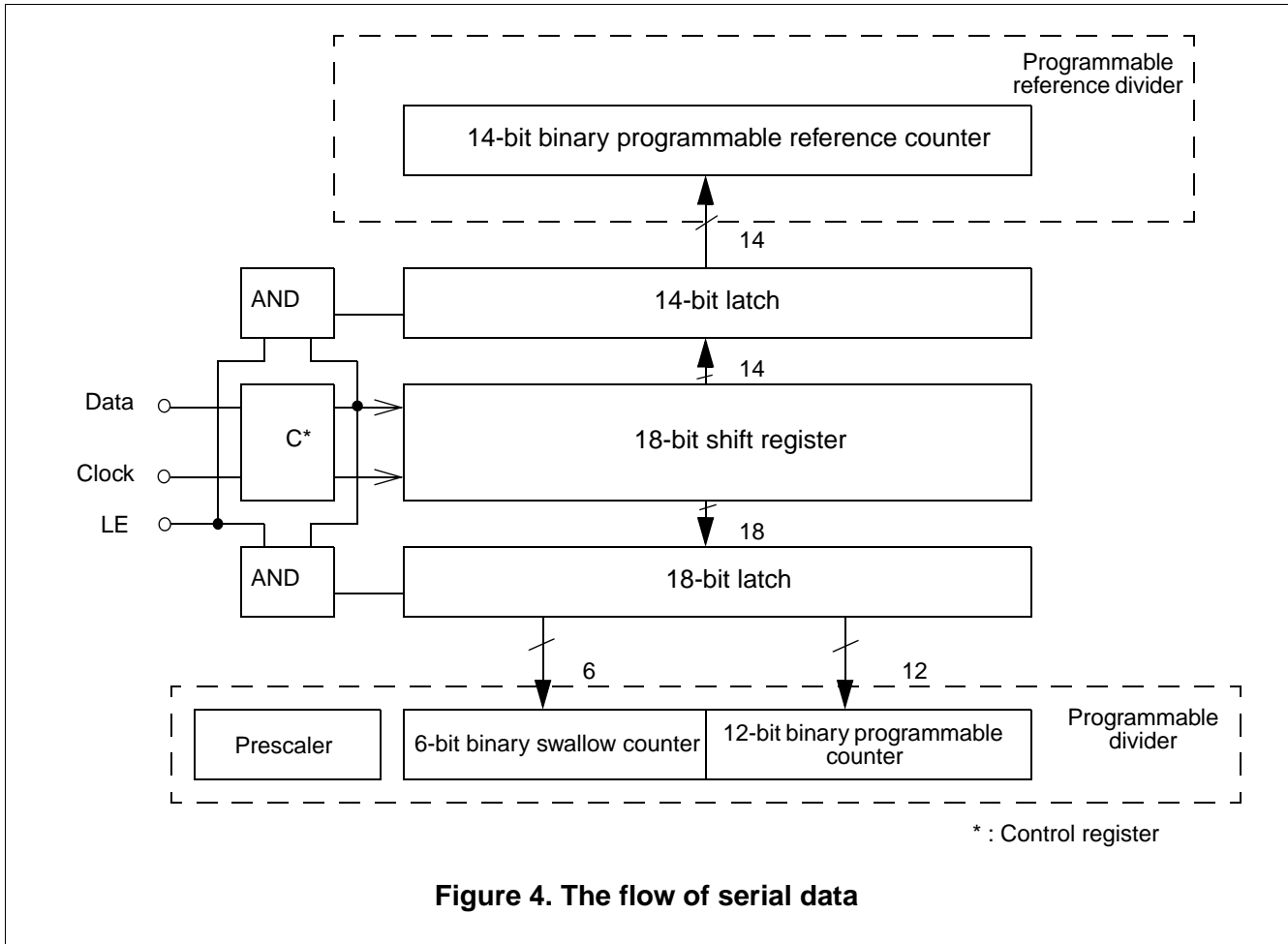

Figure 4. The flow of serial data

## (3) Setting the divide ratio for the programmable divider

Columns A0 to A5 of Table 2.1 represent the divide ratio of the swallow counter and columns N0 to N11 of Table 2.2 represent the divide ratio of programmable counter.

Table. 2 Divide ratio for the programmable divider

Table.2.1 Swallow counter divider A

Divide ratio (A)	A 0	A 1	A 2	A 3	A 4	A 5
0	0	0	0	0	0	0
1	1	0	0	0	0	0
·	·	·	·	·	·	·
63	1	1	1	1	1	1

Table2.2 Programmable counter divider N

Divide ratio (N)	N 0	N 1	N 2	N 3	N 4	N 5	N 6	N 7	N 8	N 9	N 10	N 11
5	1	0	1	0	0	0	0	0	0	0	0	0
6	0	1	1	0	0	0	0	0	0	0	0	0
·	·	·	·	·	·	·	·	·	·	·	·	·
4095	1	1	1	1	1	1	1	1	1	1	1	1

Note: Less than 5 is prohibited.

## (4) Setting the divide ratio for the programmable reference divider

Columns R0-R13 of Table 3 represent the divide ratio of the programmable reference counter. The control bit is set to 1.

**Table.3 Divide ratio for the programmable reference divider**

Divide ratio (R)	R 0	R 1	R 2	R 3	R 4	R 5	R 6	R 7	R 8	R 9	R 10	R 11	R 12	R 13
5	1	0	1	0	0	0	0	0	0	0	0	0	0	0
6	0	1	1	0	0	0	0	0	0	0	0	0	0	0
.	.	.	.	.	.	.	.	.	.	.	.	.	.	.
16383	1	1	1	1	1	1	1	1	1	1	1	1	1	1

## (5) Setting data input timing

The MB15C02 uses 19 bits of serial data for the programmable divider and 15 bits for the programmable reference divider. When more bits of serial data than defined for the target divider are received, only the last valid serial data bits are effective.

To set the divide ratio for the MB15C02 dividers, it is necessary to supply the Data, Clock, and LE signals at the timing shown in Figure 5.

$t_1 (\geq 1 \mu s)$ : Data setup time       $t_2 (\geq 1 \mu s)$ : Data hold time       $t_3 (\geq \mu s)$ : Clock pulse width

$t_4 (\geq 1 \mu s)$ : LE setup time to the rising edge of last clock       $t_5 (\geq 1 \mu s)$ : LE pulse width

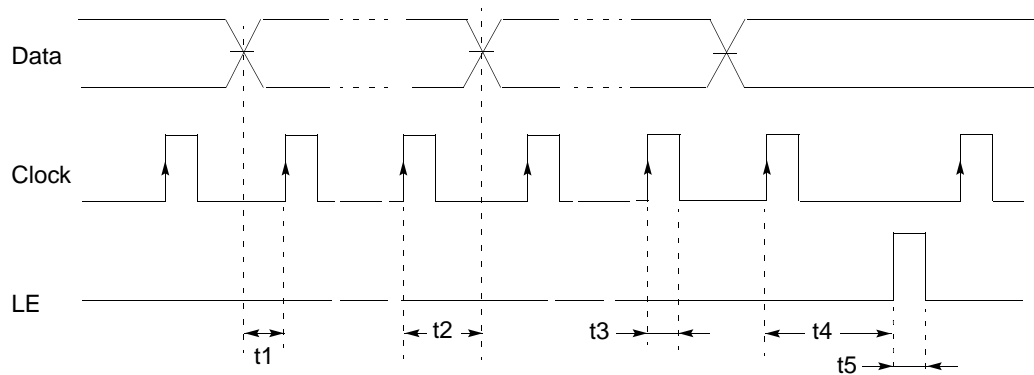

**Figure 5. Serial data input timing**

Since the divide ratios are unpredictable when the MB15C02 is turned on, it is necessary to initialize the divide ratio for both dividers at power-on time. As shown in Figure 6, after setting the divide ratio for one of the dividers (e.g., programmable reference divider), set LE to "H" level before setting the divide ratio for the other dividers (e.g., programmable divider). To change the divide ratio of one of the divider after initialization, input the serial data only for that divider (the divide ratio for the other divider is preserved).

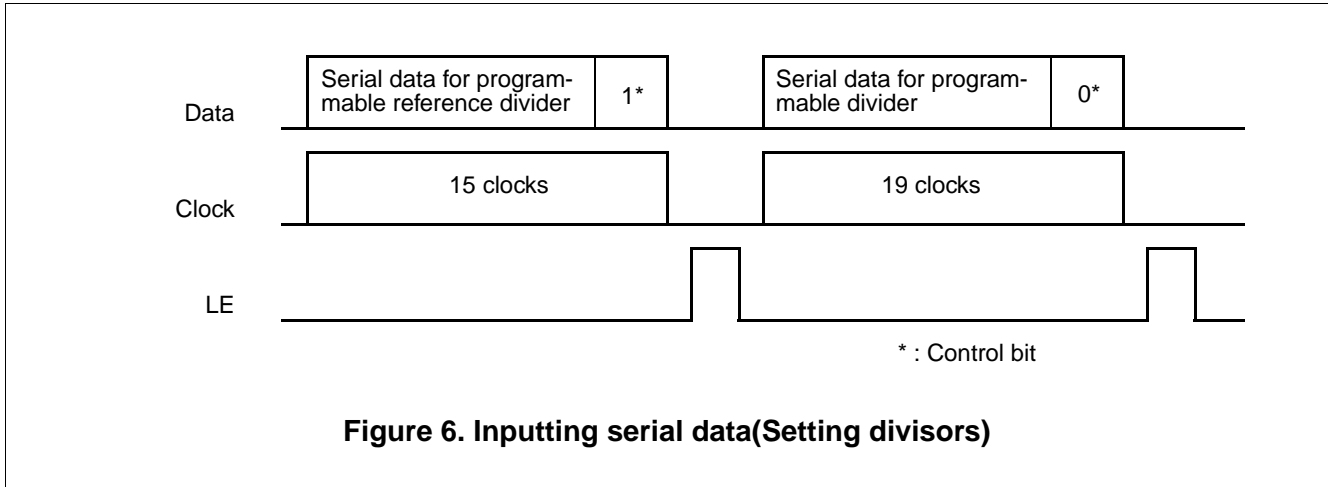

## ■ TYPICAL CHARACTERISTICS

### 1. fin Input Sensitivity

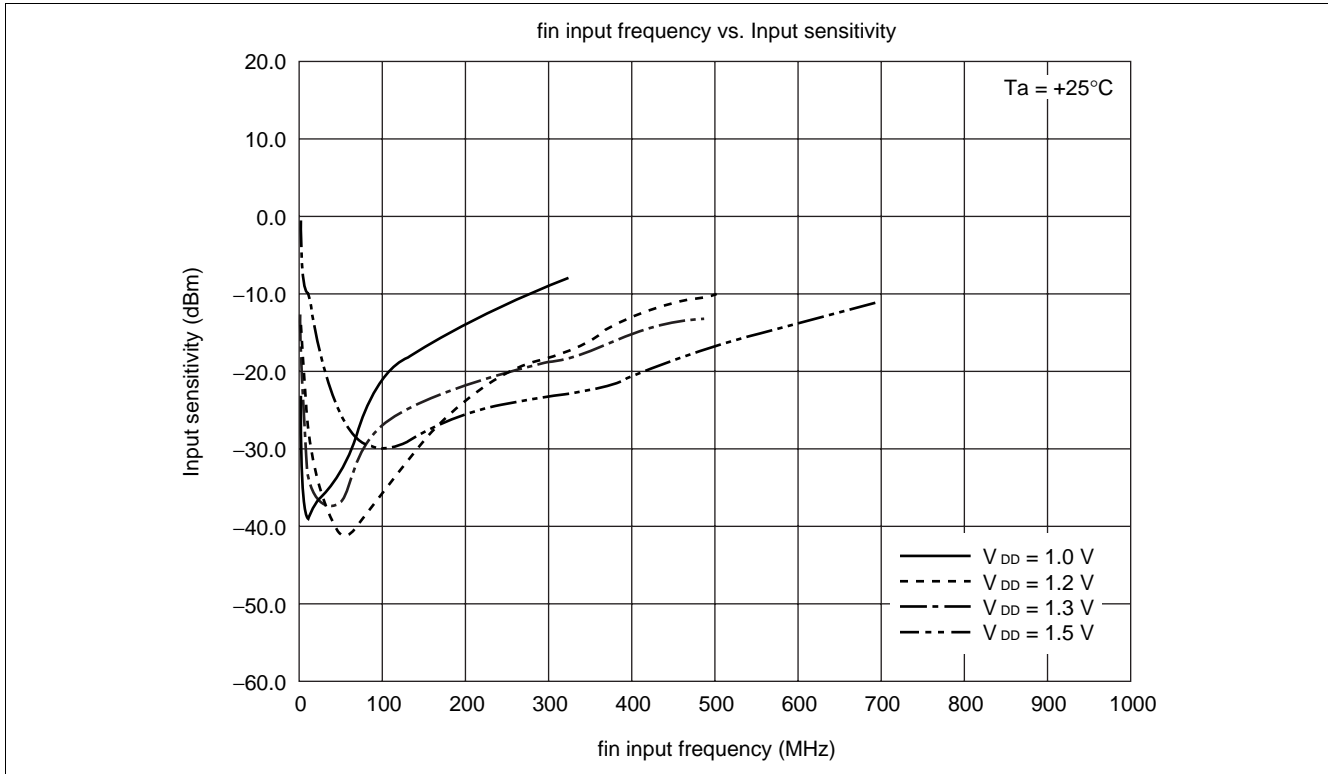

### 2. OSC<sub>IN</sub> Input Sensitivity

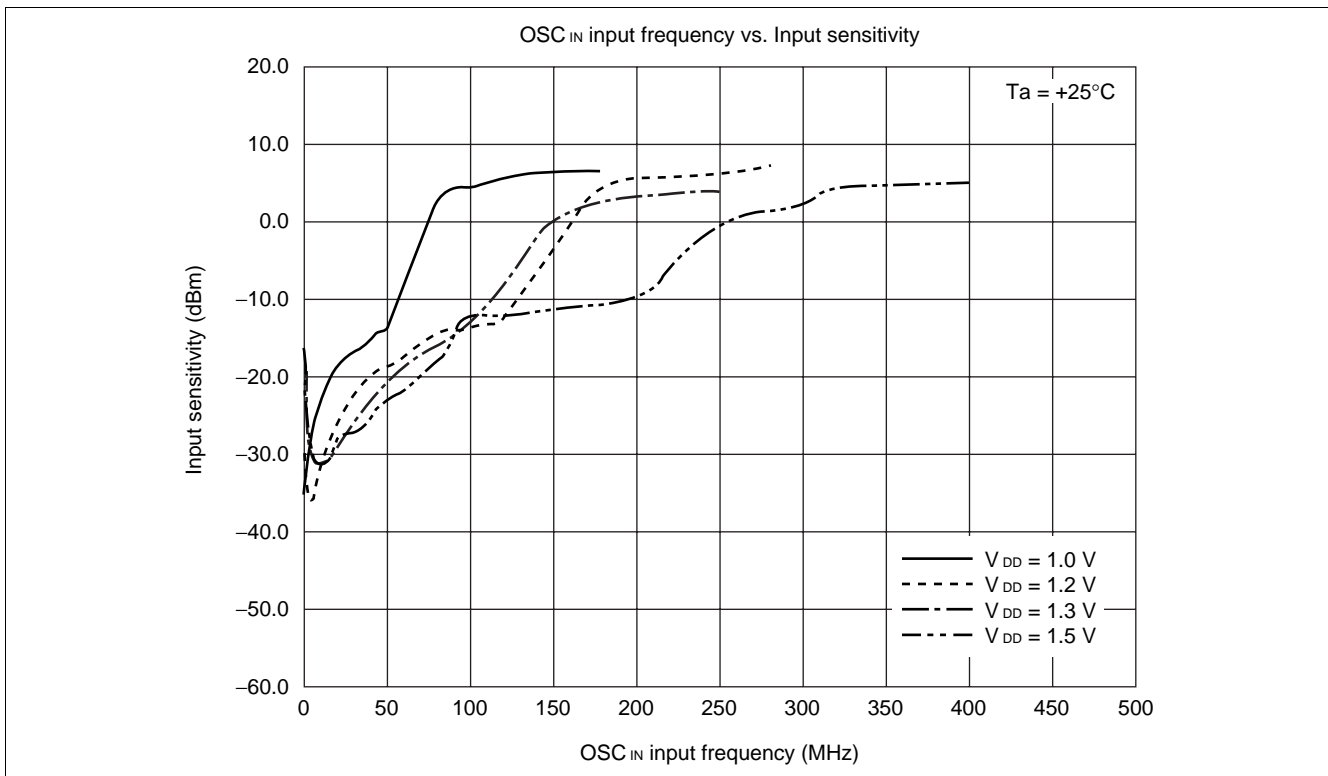



### 3. fin Power Supply Voltage

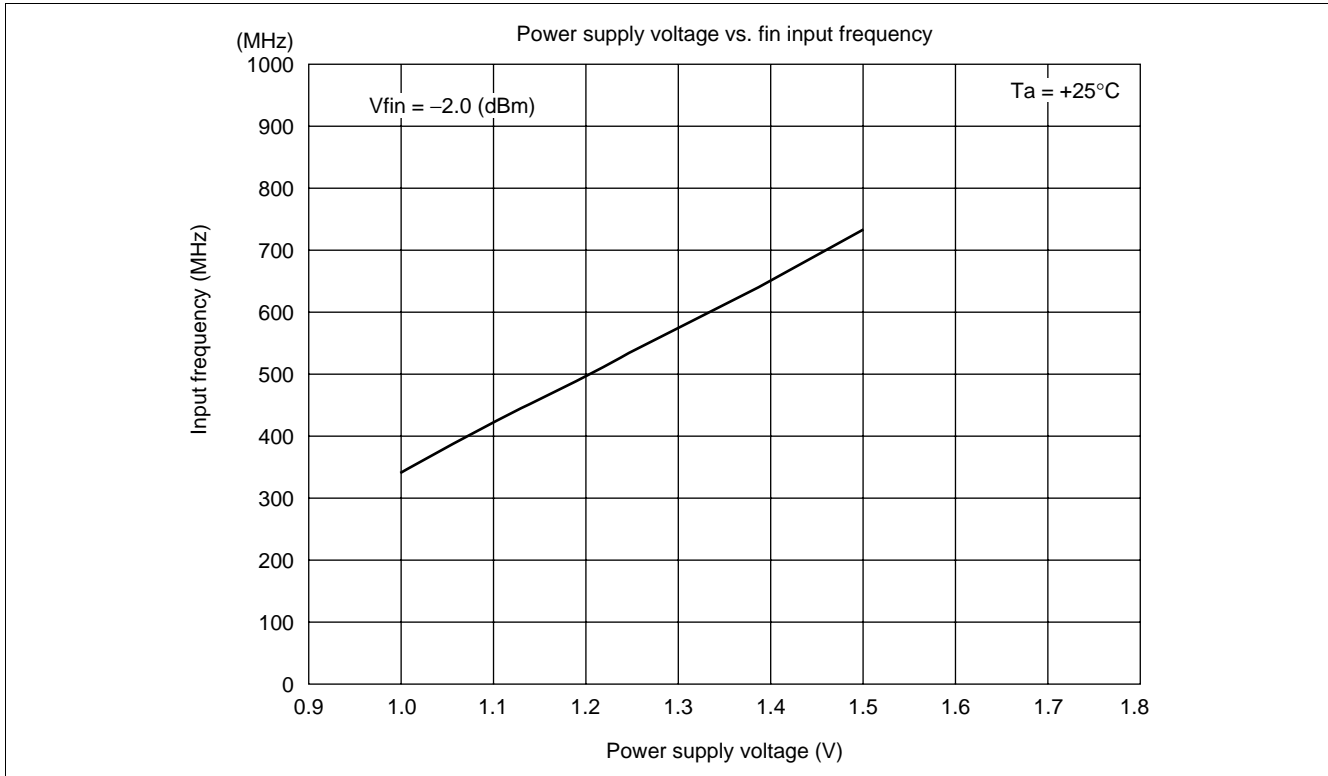

### 4. OSC<sub>IN</sub> Power Supply Voltage

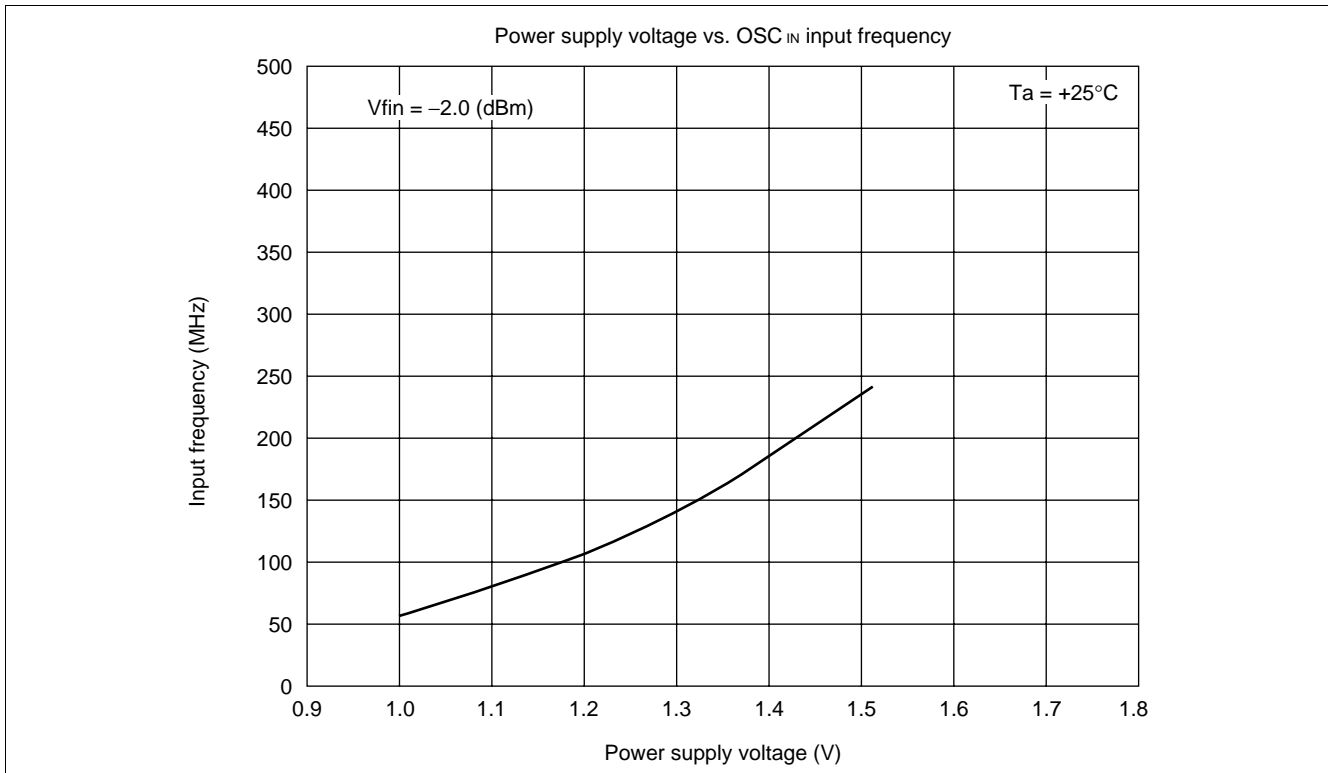

## 5. I<sub>DD</sub> Power Supply Current

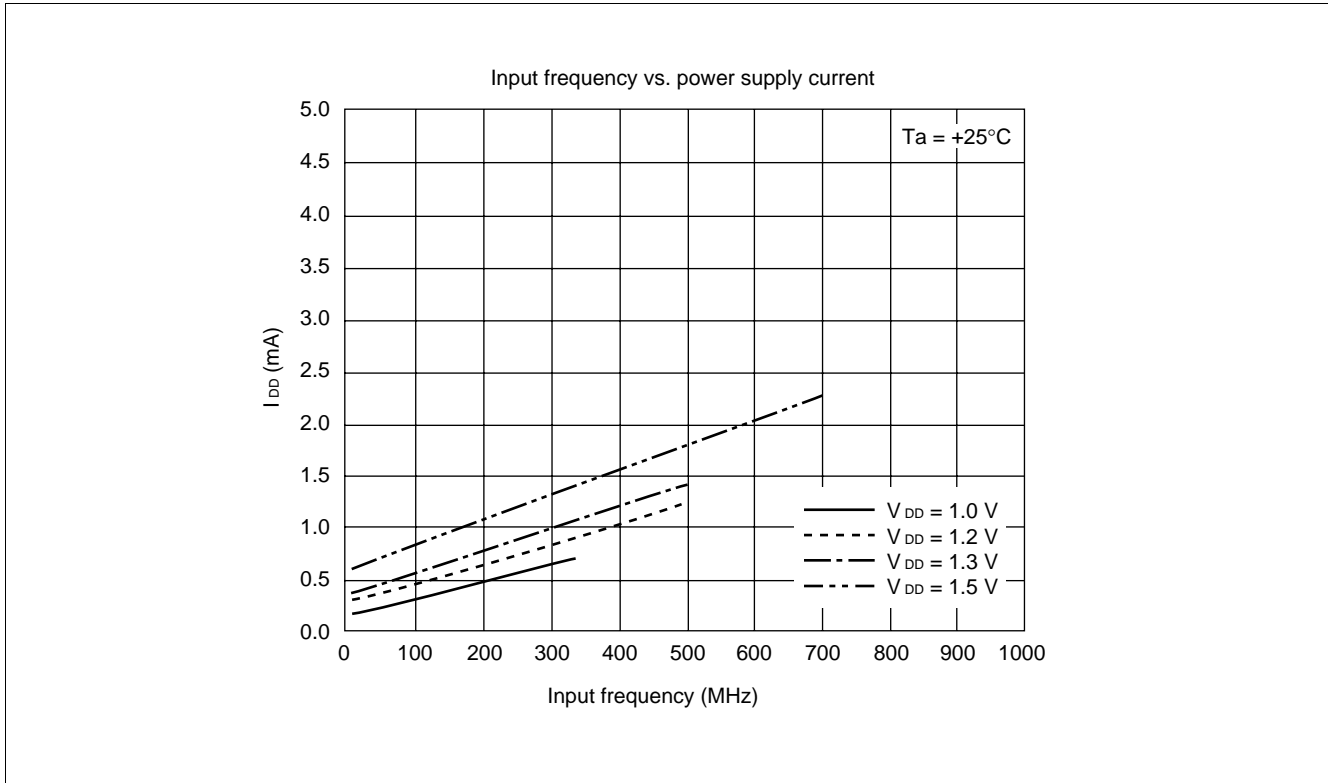

## 6. Do (Charge Pump) Power Supply Voltage

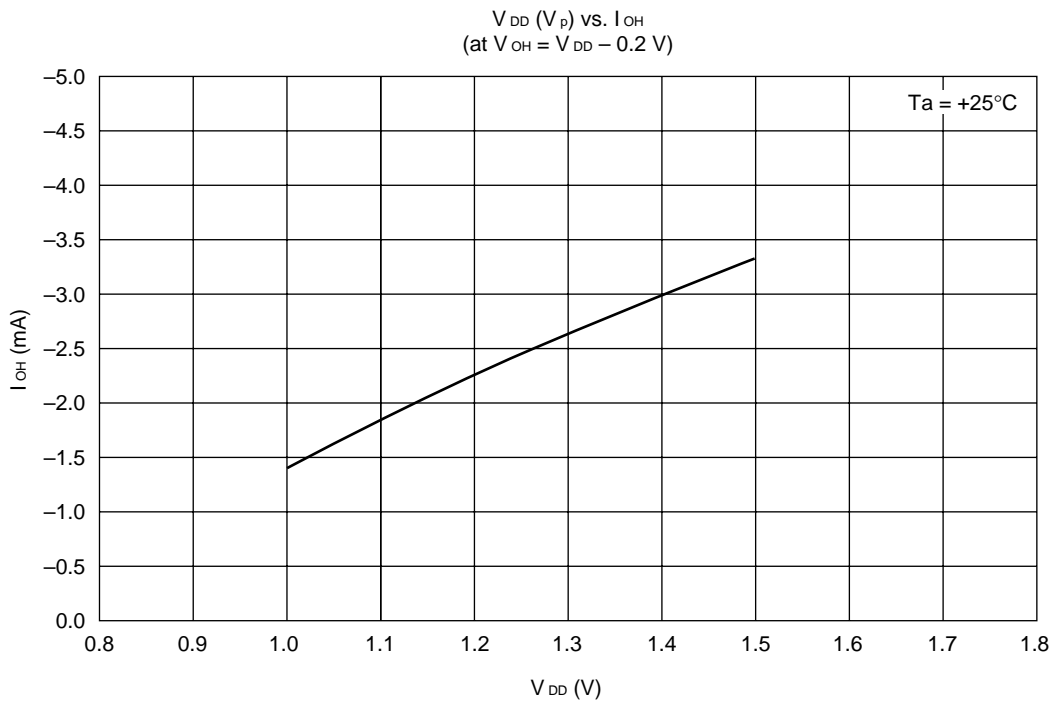
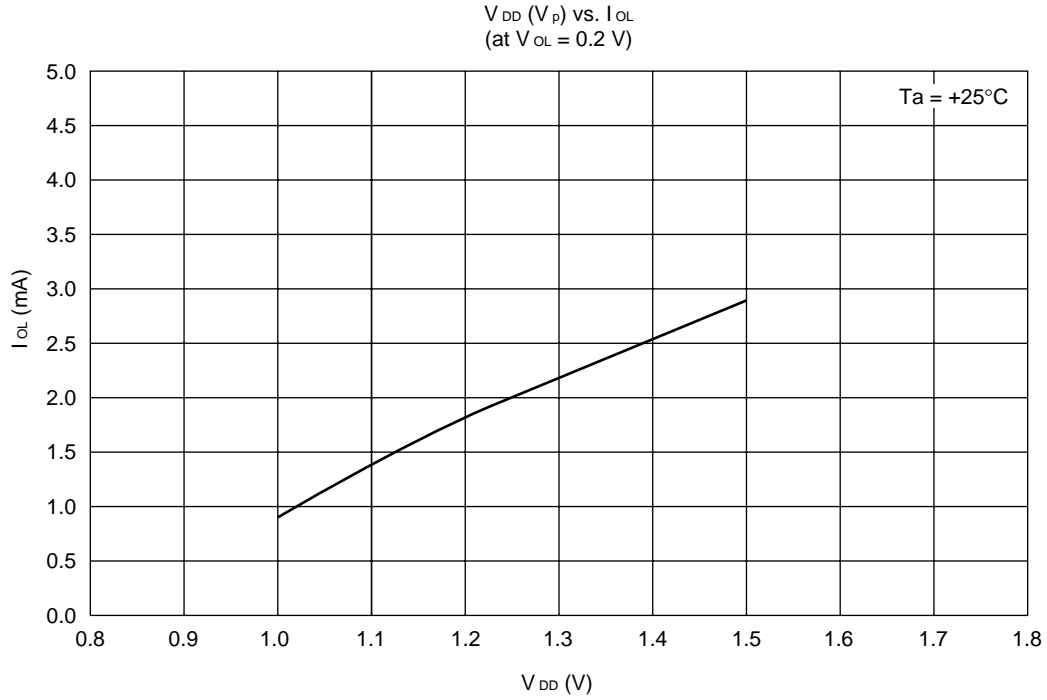

## 7. Spectrum Wave Form

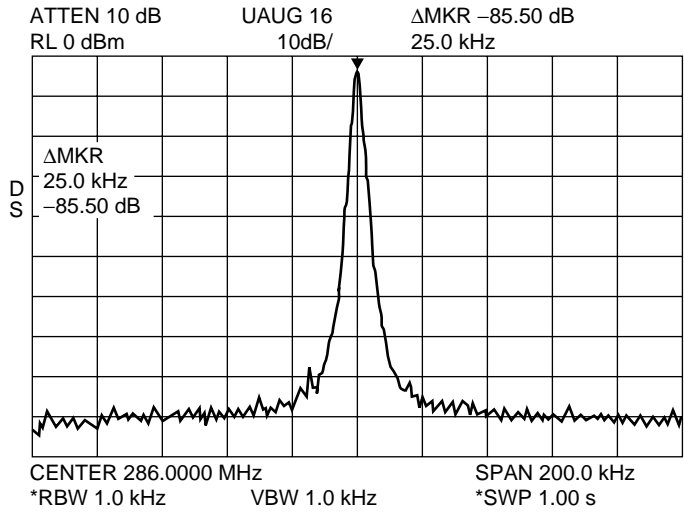

- LOCK Frequency : 286.0 MHz  
(fr = 25 kHz)
- $V_{DD} = 1.2\text{ V}$ ,  $V_P = 1.2\text{ V}$   
 $T_a = +25^\circ\text{C}$

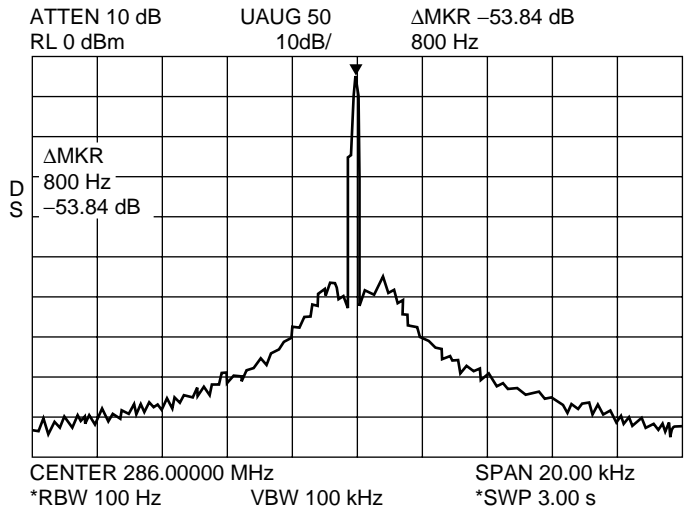

- LOCK Frequency : 286.0 MHz  
(fr = 25 kHz)
- $V_{DD} = 1.2\text{ V}$ ,  $V_P = 1.2\text{ V}$   
 $T_a = +25^\circ\text{C}$

• Test circuit

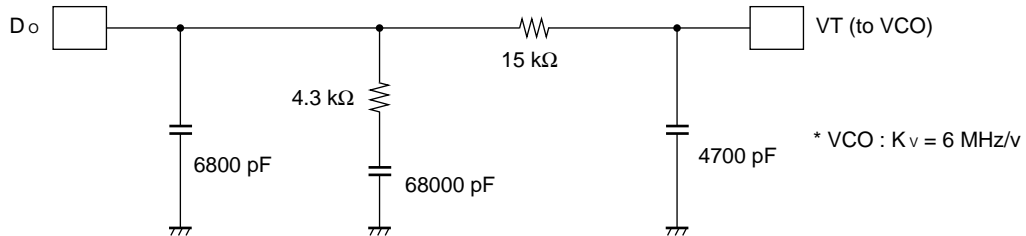

## 8. Lock Up Time

- LOCK Frequency: 290.0 MHz to 286.0 MHz  
(fr = 25 kHz)
- $V_{DD} = 1.2\text{ V}$ ,  $V_P = 1.2\text{ V}$ ,  $T_a = +25^\circ\text{C}$   
290.0 MHz  $\rightarrow$  286.0 MHz, within  $\pm 1\text{ kHz}$

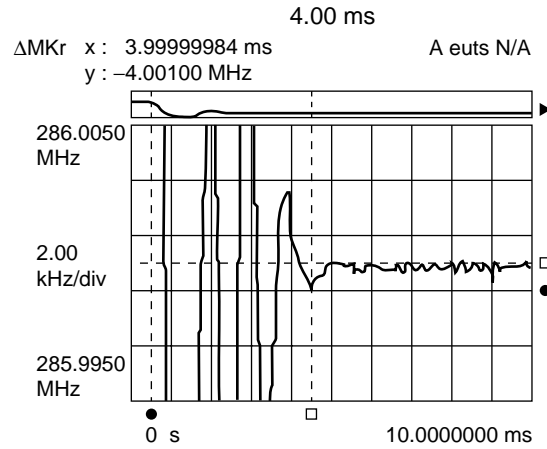

- LOCK Frequency: 286.0 MHz to 290.0 MHz  
(fr = 25 kHz)
- $V_{DD} = 1.2\text{ V}$ ,  $V_P = 1.2\text{ V}$ ,  $T_a = +25^\circ\text{C}$   
286.0 MHz  $\rightarrow$  290.0 MHz, within  $\pm 1\text{ kHz}$

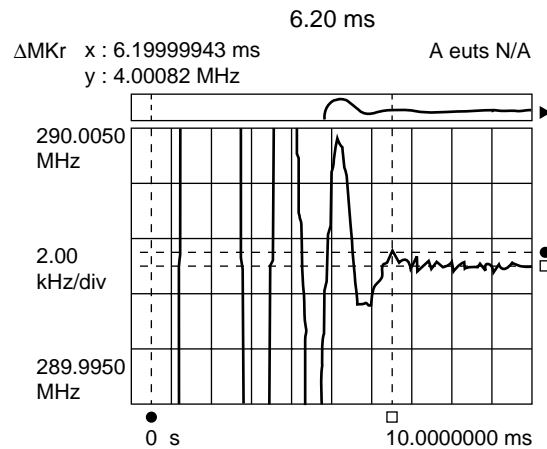

(Continued)

# MB15C02

(Continued)

- LOCK Frequency: PS on to 286.0 MHz  
(fr = 25 kHz)
- $V_{DD} = 1.2\text{ V}$ ,  $V_P = 1.2\text{ V}$ ,  $T_a = +25^\circ\text{C}$   
PS ON  $\rightarrow$  286.0 MHz, within  $\pm 1\text{ kHz}$

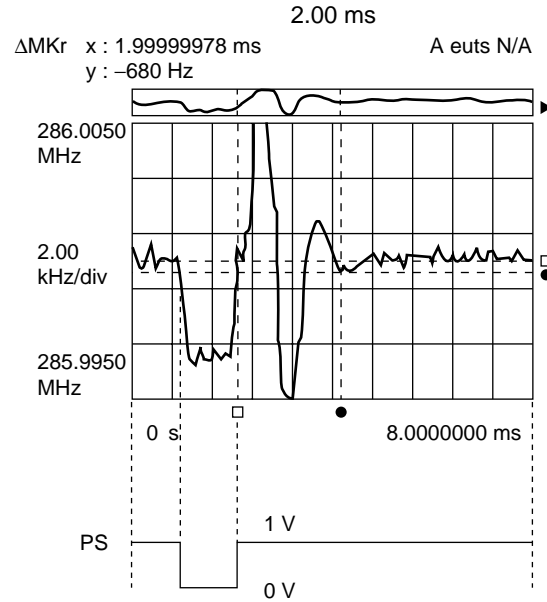

## ■ USAGE PRECAUTIONS

- This device should be transported and stored in anti-static containers.
- This is a static-sensitive device; take proper anti-ESD precautions. Ensure that personnel and equipment are properly grounded. Cover workbenches with grounded conductive mats.
- Always turn the power supply off before inserting or removing the device from its socket.
- Protect leads with a conductive sheet when handling or transporting PC boards with devices.

## ■ ORDERING INFORMATION

Parts number	Package	Remarks
MB15C02PFV1	16-pin Plastic SSOP (FPT-16P-M05)	
MB15C02PFV2	20-pin Plastic SSOP (FPT-20P-M03)	

## ■ PACKAGE DIMENSIONS

16 pins, Plastic SSOP  
(FPT-16P-M05)

\*: These dimensions do not include resin protrusion.

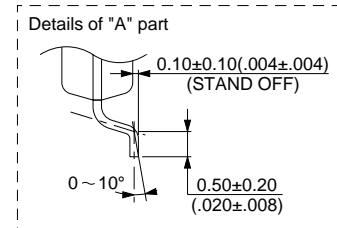
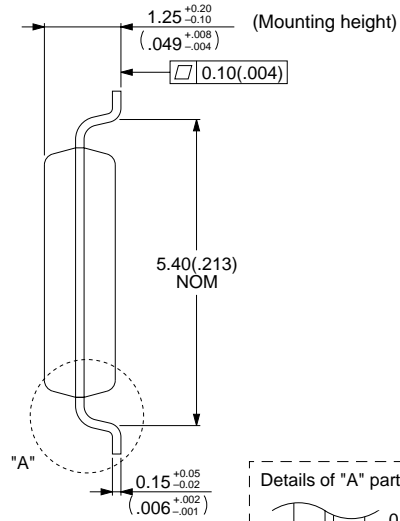
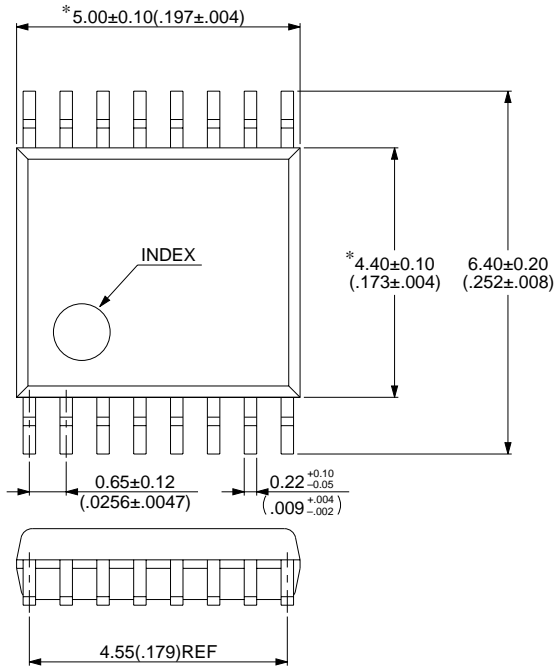

© 1994 FUJITSU LIMITED F16013S-2C-4

Dimensions in mm (inches)

(Continued)

# MB15C02

(Continued)

20 pins, Plastic SSOP  
(FPT-20P-M03)

\*: These dimensions do not include resin protrusion.

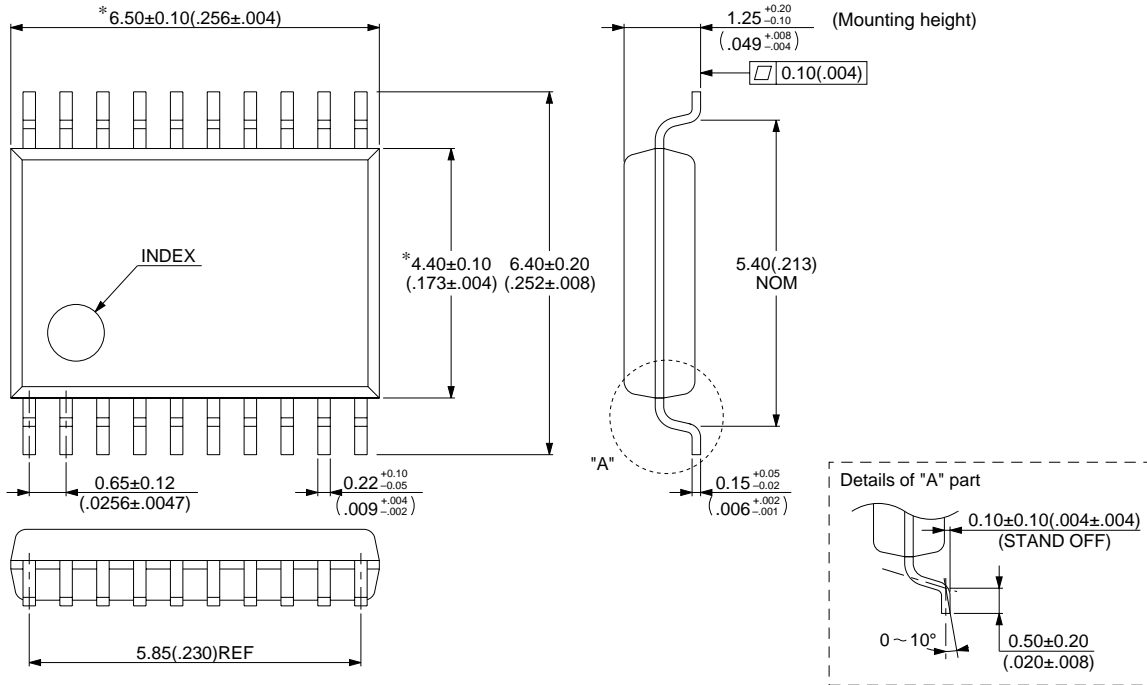

© 1994 FUJITSU LIMITED F20012S-2C-4

Dimensions in mm (inches)



# FUJITSU LIMITED

*For further information please contact:*

## **Japan**

FUJITSU LIMITED  
Corporate Global Business Support Division  
Electronic Devices  
KAWASAKI PLANT, 4-1-1, Kamikodanaka  
Nakahara-ku, Kawasaki-shi  
Kanagawa 211-8588, Japan  
Tel: 81(44) 754-3763  
Fax: 81(44) 754-3329

*<http://www.fujitsu.co.jp/>*

## **North and South America**

FUJITSU MICROELECTRONICS, INC.  
Semiconductor Division  
3545 North First Street  
San Jose, CA 95134-1804, USA  
Tel: (408) 922-9000  
Fax: (408) 922-9179

Customer Response Center  
*Mon. - Fri.: 7 am - 5 pm (PST)*  
Tel: (800) 866-8608  
Fax: (408) 922-9179

*<http://www.fujitsumicro.com/>*

## **Europe**

FUJITSU MIKROELEKTRONIK GmbH  
Am Siebenstein 6-10  
D-63303 Dreieich-Buchsschlag  
Germany  
Tel: (06103) 690-0  
Fax: (06103) 690-122

*<http://www.fujitsu-edc.com/>*

## **Asia Pacific**

FUJITSU MICROELECTRONICS ASIA PTE LTD  
#05-08, 151 Lorong Chuan  
New Tech Park  
Singapore 556741  
Tel: (65) 281-0770  
Fax: (65) 281-0220

*<http://www.fmap.com.sg/>*

F9902

© FUJITSU LIMITED Printed in Japan

All Rights Reserved.

The contents of this document are subject to change without notice. Customers are advised to consult with FUJITSU sales representatives before ordering.

The information and circuit diagrams in this document are presented as examples of semiconductor device applications, and are not intended to be incorporated in devices for actual use. Also, FUJITSU is unable to assume responsibility for infringement of any patent rights or other rights of third parties arising from the use of this information or circuit diagrams.

FUJITSU semiconductor devices are intended for use in standard applications (computers, office automation and other office equipment, industrial, communications, and measurement equipment, personal or household devices, etc.).

### **CAUTION:**

Customers considering the use of our products in special applications where failure or abnormal operation may directly affect human lives or cause physical injury or property damage, or where extremely high levels of reliability are demanded (such as aerospace systems, atomic energy controls, sea floor repeaters, vehicle operating controls, medical devices for life support, etc.) are requested to consult with FUJITSU sales representatives before such use. The company will not be responsible for damages arising from such use without prior approval.

Any semiconductor devices have an inherent chance of failure. You must protect against injury, damage or loss from such failures by incorporating safety design measures into your facility and equipment such as redundancy, fire protection, and prevention of over-current levels and other abnormal operating conditions.

If any products described in this document represent goods or technologies subject to certain restrictions on export under the Foreign Exchange and Foreign Trade Law of Japan, the prior authorization by Japanese government will be required for export of those products from Japan.