

Figure # 1

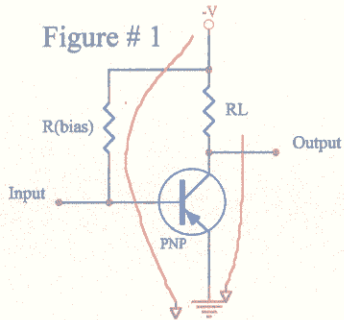

Figure # 3

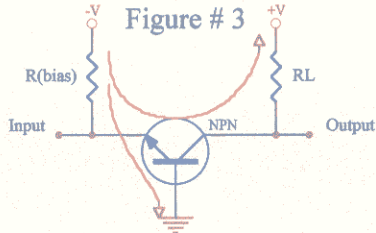

Figure # 5

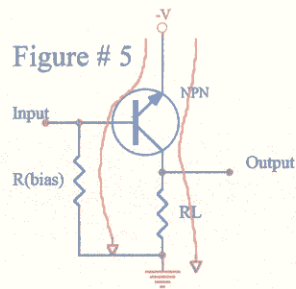

Figure # 7

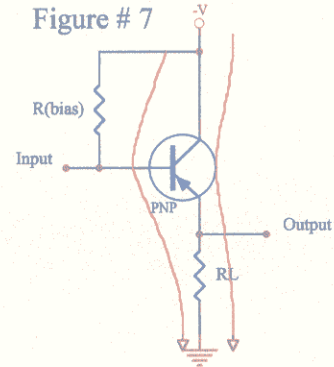

Figure # 2

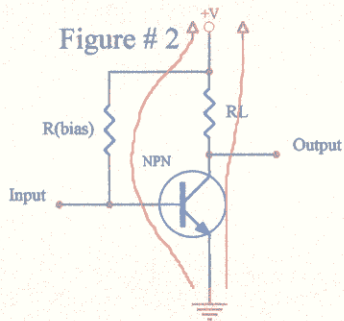

Figure # 4

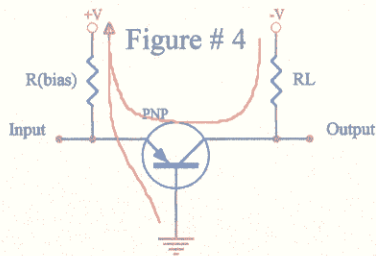

Figure # 6

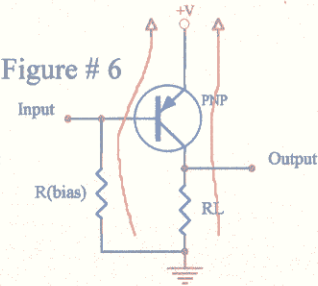
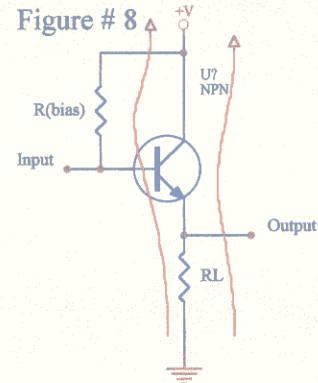

Figure # 8



Title			<b>Transistor Configurations</b>		
Size	Number	Revision		0	
A	<b>Solutions For Education</b>				
Date:	14-Jul-2001	Sheet of			
File:	C:\DDF\TRANCONF.SCH	Drawn By:		SFE-DCS, ddf	