

DALLAS

SEMICONDUCTOR

DS2016

2K x 8 3V/5V Operation Static RAM

FEATURES

- Low power CMOS design
- Standby current
 - 50 nA max at $t_A = 25^\circ\text{C}$ $V_{CC} = 3.0\text{V}$
 - 100 nA max at $t_A = 25^\circ\text{C}$ $V_{CC} = 5.5\text{V}$
 - 1 μA max at $t_A = 60^\circ\text{C}$ $V_{CC} = 5.5\text{V}$
- Full operation for $V_{CC} = 5.5\text{V}$ to 2.7V
- Data Retention Voltage = 5.5V to 2.0V
- Fast 5V access time
 - DS2016 – 100 100 ns
 - DS2016 – 150 150 ns
- Reduced-speed 3V access time
 - DS2016 – 100 250 ns
 - DS2016 – 150 250 ns
- Operating temperature range of -40°C to $+85^\circ\text{C}$
- Full static operation
- TTL compatible inputs and outputs over voltage range of 5.5V to 2.7 volts.
- Available in 24-pin DIP and 24-pin SOIC packages
- Suitable for both battery operate and battery backup applications

DESCRIPTION

The DS2016 is a 16,384-bit, low-power, fully static random access memory organized as 2048 words by 8-bits using CMOS technology. The device operates from a single power supply with a voltage input between 2.7 and 5.5 volts. The chip enable input ($\overline{\text{CE}}$) is used for device selection and can be used in order to achieve the minimum standby current mode, which facilitates both battery operate and battery backup applications. The device provides access times as fast as 100 ns when

PIN ASSIGNMENT

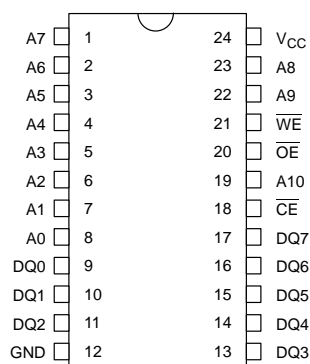

DS2016 24-PIN DIP (600 MIL)
DS2016S 24-PIN SOIC (330 MIL)

PIN DESCRIPTION

| | |
|------------------------|-------------------------------------|
| A0 – A10 | – Address Inputs |
| DQ0 – DQ7 | – Data Input/Output |
| $\overline{\text{CE}}$ | – Chip Enable Input |
| $\overline{\text{WE}}$ | – Write Enable Input |
| $\overline{\text{OE}}$ | – Output Enable Input |
| V_{CC} | – Power Supply Input 2.7V – 5.5V |
| GND | – Ground |

operated from a 5 volt power supply input, and also provides relatively good performance of 250 ns access while operating from a 3 volt input. The device maintains TTL-level inputs and outputs over the input voltage range of 2.7 to 5.5 volts. The DS2016 is most suitable for low power applications where battery operation or battery backup for nonvolatility are required. The DS2016 is a JEDEC-standard 2K x 8 SRAM and is pin-compatible with ROM and EPROM of similar density.

OPERATION MODE

| MODE | CE | OE | WE | A0-A10 | DQ-DQ7 | POWER |
|----------|----|----|----|--------|----------|------------------|
| READ | L | L | H | STABLE | DATA OUT | I _{CCO} |
| WRITE | L | X | L | STABLE | DATA IN | I _{CCO} |
| DESELECT | L | H | H | X | HIGH-Z | I _{CCO} |
| STANDBY | H | X | X | X | HIGH-Z | I _{CCS} |

ABSOLUTE MAXIMUM RATINGS

| SYMBOL | PARAMETER | RATING |
|------------------------------------|-----------------------------|--------------------------------|
| V _{CC} | Power Supply Voltage | -0.3V to +7.0V |
| V _{IN} , V _{I/O} | Input, Input/Output Voltage | -0.3 to V _{CC} + 0.3V |
| T _{STG} | Storage Temperature | -55°C to +125°C |
| T _{OPR} | Operating Temperature | -40°C to +85°C |
| T _{SOLDER} | Soldering Temperature/Time | 260°C for 10 seconds |

CAPACITANCE(t_A = 25°C)

| PARAMETER | SYMBOL | MIN | TYP | MAX | UNITS | NOTES |
|--------------------------|------------------|-----|-----|-----|-------|-------|
| Input Capacitance | C _{IN} | | 5 | 10 | pF | |
| Input/Output Capacitance | C _{I/O} | | 5 | 12 | pF | |

+5 VOLT OPERATION**RECOMMENDED DC OPERATING CONDITIONS** $(t_A = -40^\circ\text{C to } +85^\circ\text{C})$

| PARAMETER | SYMBOL | MIN | TYP | MAX | UNITS | NOTES |
|------------------------|----------|------|-----|----------------|-------|-------|
| Power Supply Voltage | V_{CC} | 4.5 | 5.0 | 5.5 | V | |
| Input High Voltage | V_{IH} | 2.0 | | $V_{CC} + 0.3$ | V | |
| Input Low Voltage | V_{IL} | -0.3 | | 0.8 | V | |
| Data Retention Voltage | V_{DR} | 2.0 | | 5.5 | V | |

DC CHARACTERISTICS $(t_A = -40^\circ\text{C to } +85^\circ\text{C}; V_{CC} = 5V \pm 10\%)$

| PARAMETER | SYMBOL | CONDITIONS | MIN | TYP | MAX | UNITS |
|-----------------------|------------|--|------|-----|-----------|---------------|
| Input Leakage Current | I_{IL} | $0V \leq V_{IN} \leq V_{CC}$ | | | ± 0.1 | μA |
| I/O Leakage Current | I_{LO} | $\overline{CE} = V_{IH}, 0V \leq V_{IO} \leq V_{CC}$ | | | ± 0.5 | μA |
| Output High Current | I_{OH} | $V_{OH} = 2.4V$ | -1.0 | | | mA |
| Output Low Current | I_{OL} | $V_{OL} = 0.4V$ | 4.0 | | | mA |
| Standby Current | I_{CCS1} | $\overline{CE} = 2.0V$ | | | 0.3 | mA |
| Standby Current | I_{CCS2} | $\overline{CE} \geq V_{CC} - 0.5V, t_A = 60^\circ\text{C}$ | | | 1 | μA |
| Standby Current | I_{CCS2} | $\overline{CE} \geq V_{CC} - 0.5V, t_A = 25^\circ\text{C}$ | | | 100 | nA |
| Operating Current | I_{CCO} | $\overline{CE} = 0.8V, 200 \text{ ns cycle}$ | | | 55 | mA |

AC CHARACTERISTICS READ CYCLE $(t_A = -40^\circ\text{C to } +85^\circ\text{C}; V_{CC} = 5V \pm 10\%)$

| PARAMETER | SYMBOL | DS2016-100 | | | DS2016-150 | | | UNITS | NOTES |
|---|-----------|------------|-----|-----|------------|-----|-----|-------|-------|
| | | MIN | TYP | MAX | MIN | TYP | MAX | | |
| Read Cycle Time | t_{RC} | 100 | | | 150 | | | ns | |
| Access Time | t_{ACC} | | | 100 | | | 150 | ns | |
| \overline{OE} to Output Valid | t_{OE} | | | 50 | | | 70 | ns | |
| \overline{CE} to Output Valid | t_{CO} | | | 100 | | | 150 | ns | |
| \overline{CE} or \overline{OE} to Output Active | t_{COE} | 5 | | | 5 | | | ns | |
| Output High-Z from Deselection | t_{OD} | 5 | | 35 | 10 | | 60 | ns | |
| Output Hold from Address Change | t_{OH} | 5 | | | 10 | | | ns | |

AC CHARACTERISTICS WRITE CYCLE $(t_A = -40^\circ\text{C to } +85^\circ\text{C}; V_{CC} = 5\text{V} \pm 10\%)$

| PARAMETER | SYMBOL | DS2016-100 | | | DS2016-150 | | | UNITS | NOTES |
|------------------------------------|-----------|------------|-----|-----|------------|-----|-----|-------|-------|
| | | MIN | TYP | MAX | MIN | TYP | MAX | | |
| Write Cycle Time | t_{WC} | 100 | | | 150 | | | ns | |
| Write Pulse Width | t_{WP} | 75 | | | 120 | | | ns | |
| Address Setup Time | t_{AW} | 0 | | | 0 | | | ns | |
| Write Recovery Time | t_{WR} | 10 | | | 10 | | | ns | |
| Output High-Z from \overline{WE} | t_{ODW} | | | 35 | | | 70 | ns | |
| Output Active from \overline{WE} | t_{OEW} | 5 | | | 5 | | | ns | |
| Data Setup Time | t_{DS} | 40 | | | 60 | | | ns | |
| Data Hold Time | t_{DH} | 0 | | | 0 | | | ns | |

DATA RETENTION CHARACTERISTICS $(t_A = -40^\circ\text{C to } +85^\circ\text{C})$

| PARAMETER | SYMBOL | CONDITIONS | MIN | TYP | MAX | UNITS |
|---------------------------------|------------|---|-----|------|-----|---------------|
| Data Retention Supply Voltage | V_{DR} | $\overline{CE} \geq V_{CC} - 0.5\text{V}$ | 2.0 | | 5.5 | V |
| Data Retention Current at 5.5V | I_{CCR1} | $\overline{CE} \geq V_{CC} - 0.5\text{V}$ | | 0.1* | 1 | μA |
| Data Retention Current at 2.0V | I_{CCR2} | $\overline{CE} \geq V_{CC} - 0.5\text{V}$ | | 50* | 750 | nA |
| Chip Deselect to Data Retention | t_{CDR} | | 0 | | | μs |
| Recovery Time | t_R | | 2 | | | ms |

* Typical values are at 25°C

+3 VOLT OPERATION**RECOMMENDED DC OPERATING CONDITIONS** $(t_A = -40^\circ\text{C to } +85^\circ\text{C})$

| PARAMETER | SYMBOL | MIN | TYP | MAX | UNITS | NOTES |
|------------------------|----------|------|-----|----------------|-------|-------|
| Power Supply Voltage | V_{CC} | 2.7 | 3.0 | 3.5 | V | |
| Input High Voltage | V_{IH} | 2.0 | | $V_{CC} + 0.3$ | V | |
| Input Low Voltage | V_{IL} | -0.3 | | 0.6 | V | |
| Data Retention Voltage | V_{DR} | 2.0 | | 3.5 | V | |

DC CHARACTERISTICS $(t_A = -40^\circ\text{C to } +85^\circ\text{C}; V_{CC} = 2.7\text{V to } 3.5\text{V})$

| PARAMETER | SYMBOL | CONDITIONS | MIN | TYP | MAX | UNITS |
|-----------------------|------------|---|------|-----|-----------|---------------|
| Input Leakage Current | I_{IL} | $0\text{V} \leq V_{IN} \leq V_{CC}$ | | | ± 0.1 | μA |
| I/O Leakage Current | I_{LO} | $\overline{CE} = V_{IH}, 0\text{V} \leq V_{IO} \leq V_{CC}$ | | | ± 0.5 | μA |
| Output High Current | I_{OH} | $V_{OH} = 2.2\text{V}$ | -0.5 | | | mA |
| Output Low Current | I_{OL} | $V_{OL} = 0.4\text{V}$ | 4.0 | | | mA |
| Standby Current | I_{CCS1} | $\overline{CE} = 2.0\text{V}$ | | | 0.1 | mA |
| Standby Current | I_{CCS2} | $\overline{CE} \geq V_{CC} - 0.3\text{V } t_A = 60^\circ\text{C}$ | | | 500 | nA |
| Standby Current | I_{CCS2} | $\overline{CE} \geq V_{CC} - 0.3\text{V } t_A = 25^\circ\text{C}$ | | | 50 | nA |
| Operating Current | I_{CCO} | $\overline{CE} = 0.6\text{V min cycle}$ | | | 25 | mA |

AC CHARACTERISTICS READ CYCLE $(t_A = -40^\circ\text{C to } +85^\circ\text{C}; V_{CC} = 2.7\text{V to } 3.5\text{V})$

| PARAMETER | SYMBOL | MIN | TYP | MAX | UNITS | NOTES |
|---|-----------|-----|-----|-----|-------|-------|
| Read Cycle Time | t_{RC} | 250 | | | ns | |
| Access Time | t_{ACC} | | | 250 | ns | |
| \overline{OE} to Output Valid | t_{OE} | | | 120 | ns | |
| \overline{CE} to Output Valid | t_{CO} | | | 250 | ns | |
| \overline{CE} or \overline{OE} to Output Active | t_{COE} | 15 | | | ns | |
| Output High-Z from Deselection | t_{OD} | 5 | | 100 | ns | |
| Output Hold from Address Change | t_{OH} | 15 | | | ns | |

AC CHARACTERISTICS WRITE CYCLE $(t_A = -40^\circ\text{C to } +85^\circ\text{C}; V_{CC} = 2.7\text{V to } 3.5\text{V})$

| PARAMETER | SYMBOL | MIN | TYP | MAX | UNITS | NOTES |
|------------------------------------|-----------|-----|-----|-----|-------|-------|
| Write Cycle Time | t_{WC} | 250 | | | ns | |
| Write Pulse Width | t_{WP} | 190 | | | ns | |
| Address Setup Time | t_{AW} | 0 | | | ns | |
| Write Recovery Time | t_{WR} | 25 | | | ns | |
| Output High-Z from \overline{WE} | t_{ODW} | | | 90 | ns | |
| Output Active from \overline{WE} | t_{OEW} | 5 | | | ns | |
| Data Setup Time | t_{DS} | 100 | | | ns | |
| Data Hold Time | t_{DH} | 0 | | | ns | |

DATA RETENTION CHARACTERISTICS $(t_A = -40^\circ\text{C to } +85^\circ\text{C})$

| PARAMETER | SYMBOL | CONDITIONS | MIN | TYP | MAX | UNITS |
|---------------------------------|------------|---|-----|-----|------|---------------|
| Data Retention Supply Voltage | V_{DR} | $\overline{CE} \geq V_{CC} - 0.3\text{V}$ | 2.0 | | 3.5 | V |
| Data Retention Current at 3.5V | I_{CCR1} | $\overline{CE} \geq V_{CC} - 0.3\text{V}$ | | 50* | 1000 | nA |
| Data Retention Current at 2.0V | I_{CCR2} | $\overline{CE} \geq V_{CC} - 0.3\text{V}$ | | 50* | 750 | nA |
| Chip Deselect to Data Retention | t_{CDR} | | 0 | | | μs |
| Recovery Time | t_R | | 2 | | | ms |

* Typical values are at 25°C

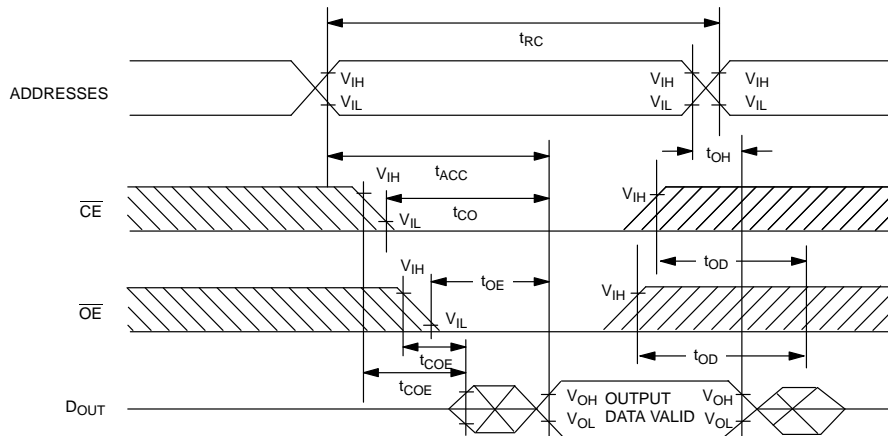
TIMING DIAGRAM: READ CYCLE

SEE NOTE 1

TIMING DIAGRAM: WRITE CYCLE 1

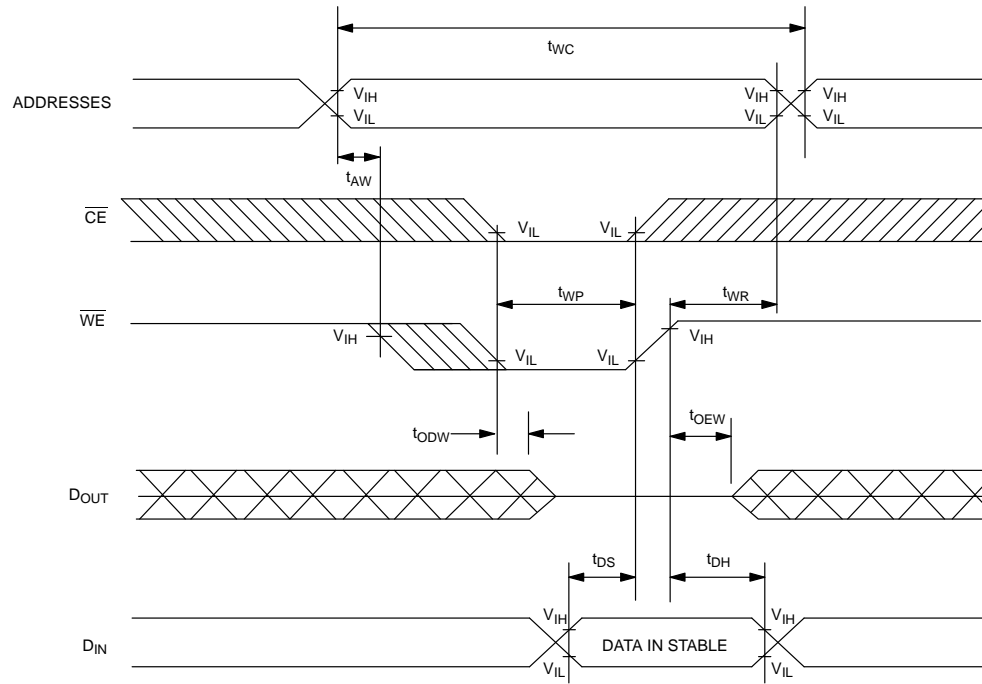

SEE NOTES 2, 3, 4, 5, 6 AND 7

TIMING DIAGRAM: WRITE CYCLE 2

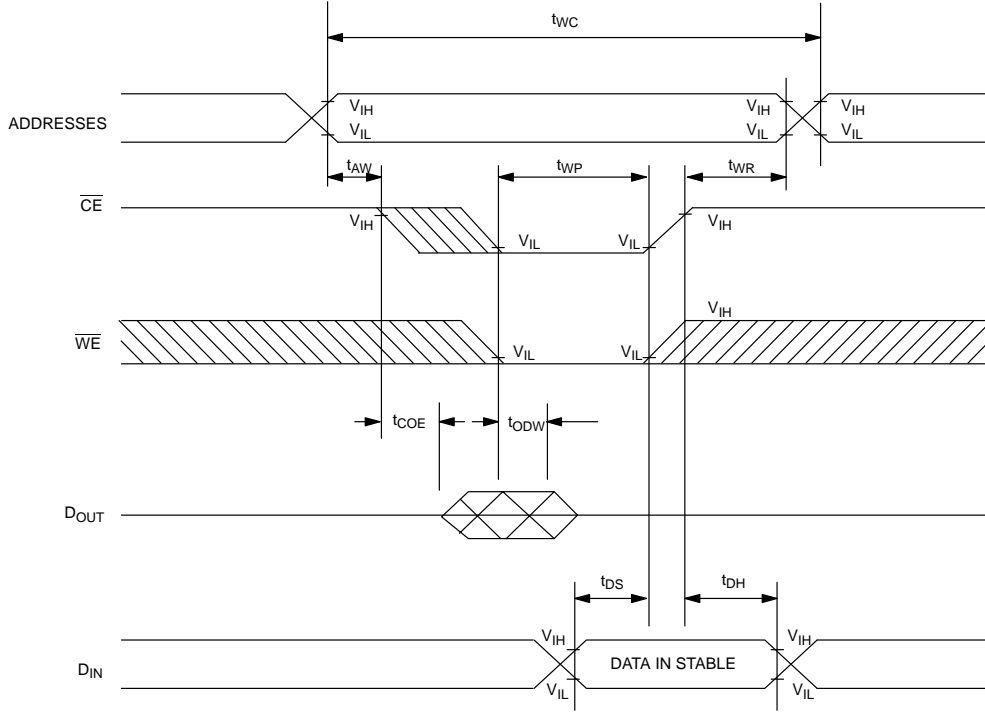

SEE NOTES 2, 3, 4, 5, 6 AND 7

TIMING DIAGRAM: DATA RETENTION – POWER UP, POWER DOWN Figure 1

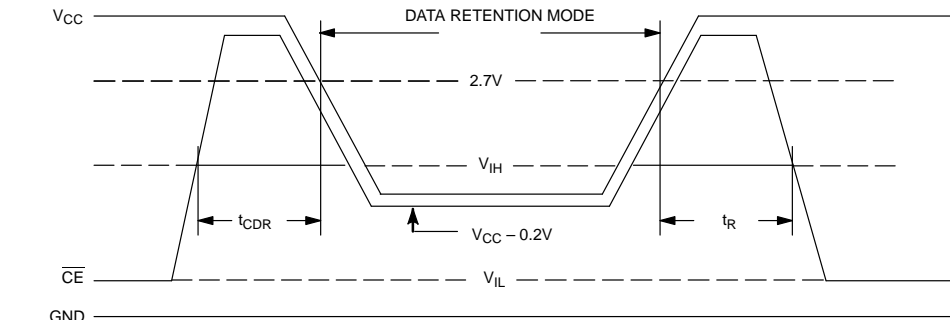

SEE NOTE 8

NOTES:

1. \overline{WE} is high for read cycles.
2. $\overline{OE} = V_{IH}$ or V_{IL} . If $\overline{OE} = V_{IH}$ during write cycle, the output buffers remain in a high impedance state.
3. t_{WP} is specified as the logical AND of \overline{CE} and \overline{WE} . t_{WP} is measured from the latter of \overline{CE} or \overline{WE} going low to the earlier of \overline{CE} or \overline{WE} going high.
4. t_{DH} and t_{DS} are measured from the earlier of \overline{CE} or \overline{WE} going high.
5. If the \overline{CE} low transition occurs simultaneously with or later than the \overline{WE} low transition, the output buffers remain in a high impedance state.
6. If the \overline{CE} high transition occurs prior to or simultaneously with the \overline{WE} high transition, the output buffers remain in a high impedance state.
7. If \overline{WE} is low or the \overline{WE} low transition occurs prior to or simultaneously with the \overline{CE} low transition, the output buffers remain in a high impedance state.
8. If the V_{IH} level of \overline{CE} is 2.0V during the period that V_{CC} voltage is going down from 4.5V to 2.7V, I_{CCS1} current flows.
9. The DS2016 maintains full operation from 5.5V to 2.7V. The electrical characteristics tables show two tested and guaranteed points of operation. For operation between 4.5V and 3.5 volts, used the composite worst case characteristics from both 5V and 3V operation for design purposes.

DC TEST CONDITIONS

Outputs Open

All voltages are referenced to ground.

AC TEST CONDITIONS

Output Load: 100 pF + 1TTL Gate

Input Pulse Levels: 0V – 3.0V

Timing Measurement Reference Levels

Input: 1.5V

Output: 1.5V

Input Pulse Rise and Fall Times: 5 ns

DS2016 24-PIN DIP

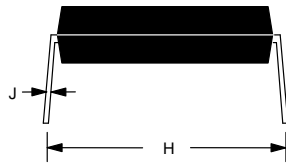
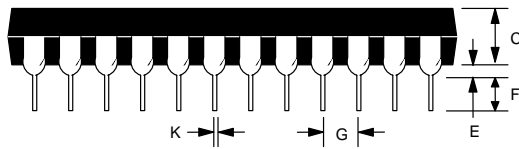
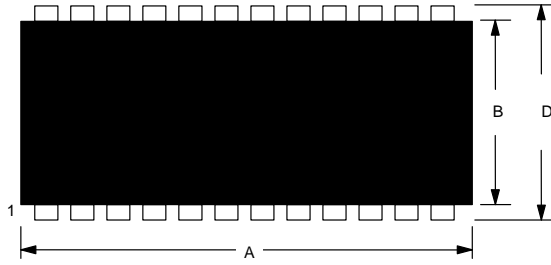

| PKG | 24-PIN | |
|-------|--------|-------|
| | DIM | MIN |
| A IN. | 1.245 | 1.270 |
| MM | 31.62 | 32.25 |
| B IN. | 0.530 | 0.550 |
| MM | 13.46 | 13.97 |
| C IN. | 0.140 | 0.160 |
| MM | 3.56 | 4.06 |
| D IN. | 0.600 | 0.625 |
| MM | 15.24 | 15.88 |
| E IN. | 0.015 | 0.050 |
| MM | 0.380 | 1.27 |
| F IN. | 0.120 | 0.145 |
| MM | 3.05 | 3.68 |
| G IN. | 0.090 | 0.110 |
| MM | 2.29 | 2.79 |
| H IN. | 0.625 | 0.675 |
| MM | 15.88 | 17.15 |
| J IN. | 0.008 | 0.012 |
| MM | 0.20 | 0.30 |
| K IN. | 0.015 | 0.022 |
| MM | 0.38 | 0.56 |

DS2016S 24-PIN SOIC

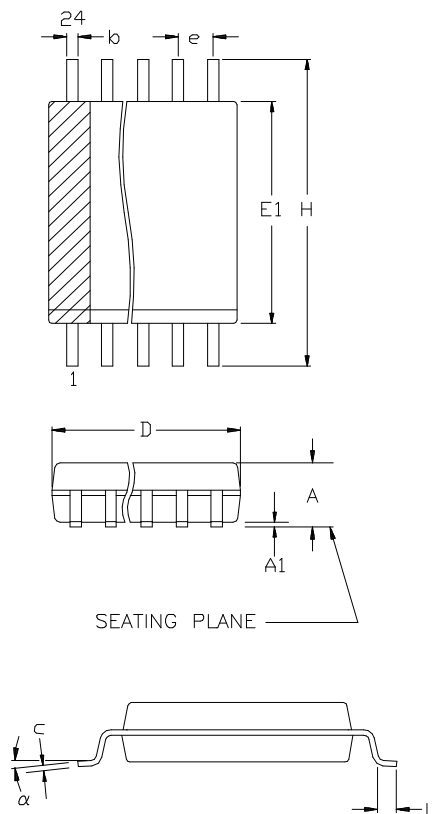

| PKG | 24-PIN | |
|--------------|-----------------------|----------------|
| | MIN | MAX |
| A IN. MM | 0.080 2.04 | 0.120 3.05 |
| A1 IN. MM | 0.002 0.05 | 0.014 0.35 |
| b IN. MM | 0.012 0.30 | 0.020 0.50 |
| C IN MM | 0.004 0.10 | 0.0125 0.32 |
| D IN. MM | 0.595 15.1 | 0.634 16.1 |
| e IN. MM | 0.050 BSC 1.27 BSC | |
| E1 IN. MM | 0.324 8.23 | 0.350 8.90 |
| H IN MM | 0.453 11.5 | 0.500 12.7 |
| L IN MM | 0.016 0.40 | 0.051 1.30 |
| α | 0° | 10° |

The chamfer on the body is optional. If it is not present, a terminal 1 identifier must be positioned so that 1/2 or more of its area is contained in the hatched zone.