

PACKAGE DIMENSIONS

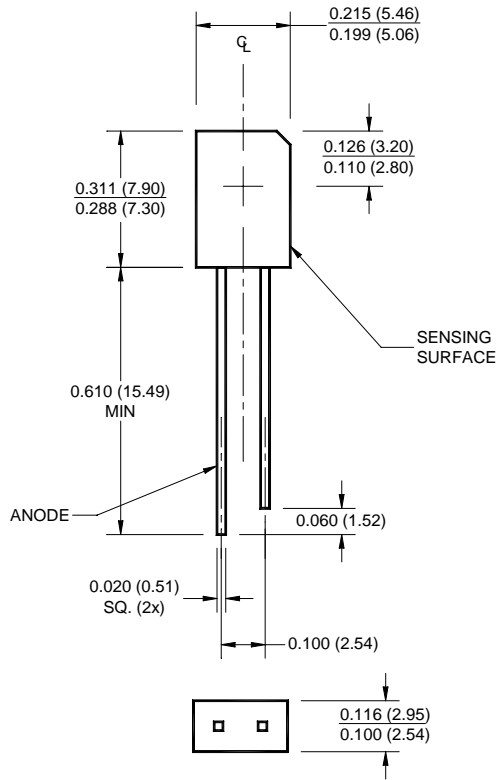

NOTES:

1. Dimensions for all drawings are in inches (mm).
2. Tolerance of $\pm .010 (.25)$ on all non-nominal dimensions unless otherwise specified.

FEATURES

- Daylight Filter
- Sidelooker Package
- Pin Photodiode
- Wide Reception Angle, 120°
- Chip Size = $.107^2$ inches (2.71^2 mm)

SCHEMATIC

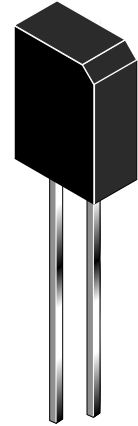
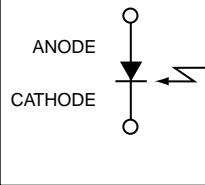

1. Derate power dissipation linearly 2.50 mW/°C above 25°C.
2. RMA flux is recommended.
3. Methanol or isopropyl alcohols are recommended as cleaning agents.
4. Soldering iron 1/16" (1.6mm) minimum from housing.
5. As long as leads are not under any stress or spring tension.
6. Light source is an GaAs LED which has a peak emission wavelength of 940 nm.
7. All measurements made under pulse conditions.

ABSOLUTE MAXIMUM RATINGS ($T_A = 25^\circ\text{C}$ unless otherwise specified)

Parameter	Symbol	Rating	Unit
Operating Temperature	T_{OPR}	-40 to +85	°C
Storage Temperature	T_{STG}	-40 to +85	°C
Soldering Temperature (Iron)(2,3,4,5)	T_{SOL-I}	240 for 5 sec	°C
Soldering Temperature (Flow)(2,3,5)	T_{SOL-F}	260 for 10 sec	°C
Reverse Voltage	V_R	32	V
Power Dissipation(1)	P_D	150	mW

ELECTRICAL / OPTICAL CHARACTERISTICS (T _A =25°C unless otherwise specified)						
PARAMETER	TEST CONDITIONS	SYMBOL	MIN	TYP	MAX	UNITS
Reverse Voltage	I _R = 0.1 mA	V _R	32		—	V
Dark Reverse Current	V _R = 10 V	I _{R(D)}	—		30	nA
Peak Sensitivity	V _R = 5 V	λ _{PK}		920		nm
Reception Angle @ 1/2 Power		Θ		+/-60		Degrees
Photo Current	E _e = 1.0 mW/cm ² , V _{CE} = 5 V ⁽⁶⁾	I _{PH}	30		—	μA
Capacitance	V _R = 3 V	C		20		pF
Rise Time	V _R = 5 V, R _L = 1 K	t _r		50		ns
Fall Time	V _R = 5 V, R _L = 1 K	t _f		50		ns

TYPICAL PERFORMANCE CURVES

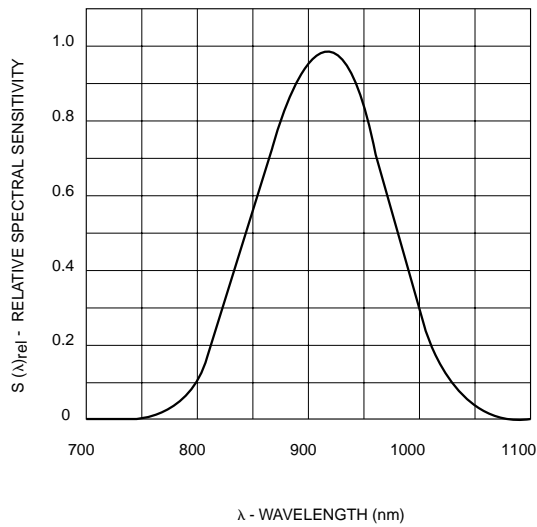

Fig. 1 Relative Spectral Sensitivity vs. Wavelength

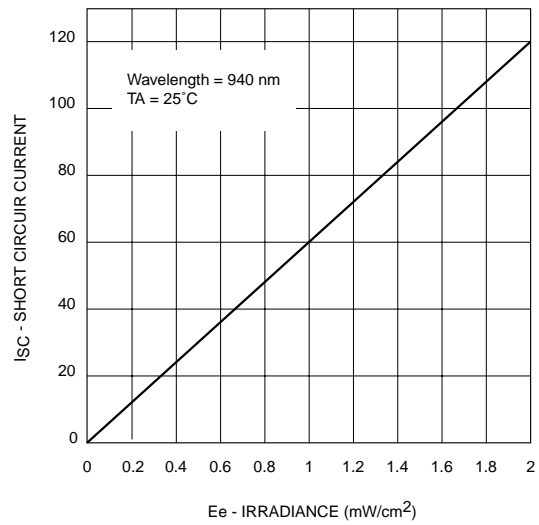

Fig. 2 Short Circuit Current vs. Irradiance

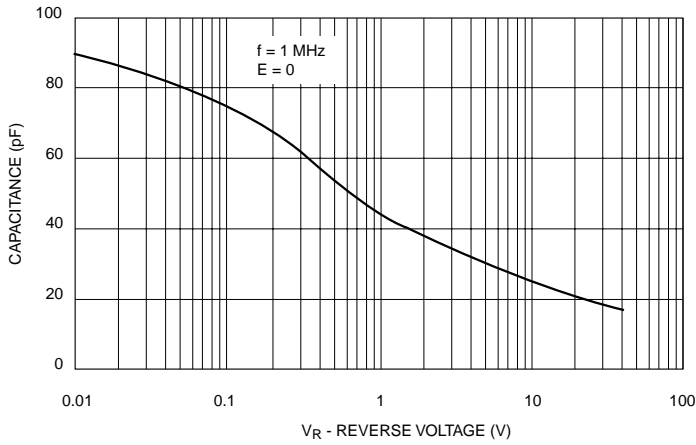

Fig. 3 Capacitance vs. Reverse Voltage

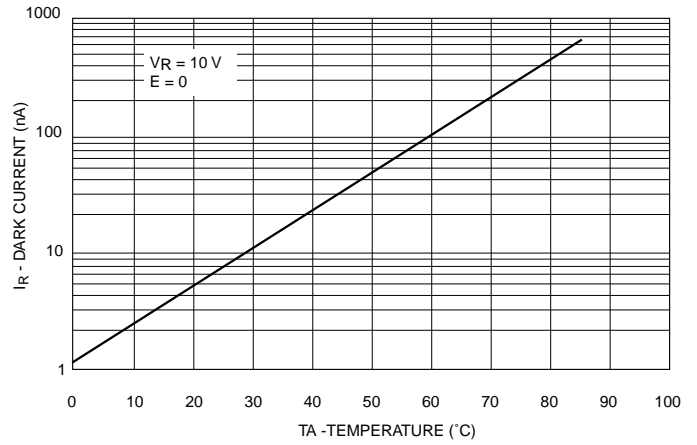

Fig. 4 Dark Current vs. Temperature

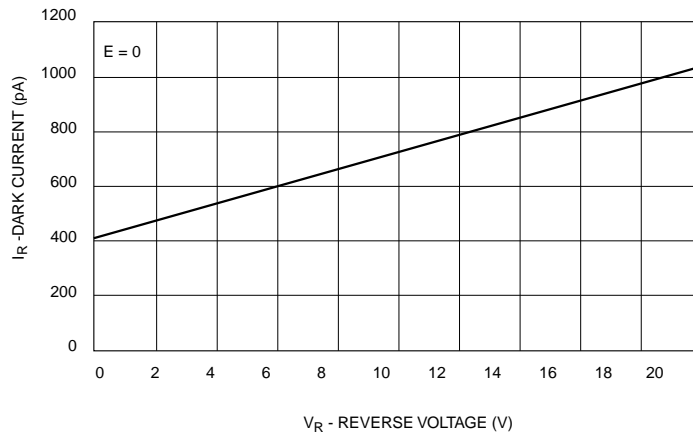

Fig. 5 Dark Current vs. Reverse Voltage

DISCLAIMER

FAIRCHILD SEMICONDUCTOR RESERVES THE RIGHT TO MAKE CHANGES WITHOUT FURTHER NOTICE TO ANY PRODUCTS HEREIN TO IMPROVE RELIABILITY, FUNCTION OR DESIGN. FAIRCHILD DOES NOT ASSUME ANY LIABILITY ARISING OUT OF THE APPLICATION OR USE OF ANY PRODUCT OR CIRCUIT DESCRIBED HEREIN; NEITHER DOES IT CONVEY ANY LICENSE UNDER ITS PATENT RIGHTS, NOR THE RIGHTS OF OTHERS.

LIFE SUPPORT POLICY

FAIRCHILD'S PRODUCTS ARE NOT AUTHORIZED FOR USE AS CRITICAL COMPONENTS IN LIFE SUPPORT DEVICES OR SYSTEMS WITHOUT THE EXPRESS WRITTEN APPROVAL OF THE PRESIDENT OF FAIRCHILD SEMICONDUCTOR CORPORATION. As used herein:

1. Life support devices or systems are devices or systems which, (a) are intended for surgical implant into the body, or (b) support or sustain life, and (c) whose failure to perform when properly used in accordance with instructions for use provided in the labeling, can be reasonably expected to result in a significant injury of the user.
2. A critical component in any component of a life support device or system whose failure to perform can be reasonably expected to cause the failure of the life support device or system, or to affect its safety or effectiveness.