

# LM4916 Boomer® Audio Power Amplifier Series

## 1.5V, Mono 85mW BTL Output, 14mW Stereo Headphone Audio Amplifier

### General Description

The unity gain stable LM4916 is both a mono differential output (for bridge-tied loads or BTL) audio power amplifier and a Single Ended (SE) stereo headphone amplifier. Operating on a single 1.5V supply, the mono BTL mode delivers 85mW into an 8Ω load at 1% THD+N. In Single Ended stereo headphone mode, the amplifier delivers 14mW per channel into a 16Ω load at 1% THD+N.

With the LM4916 packaged in the MM and LLP packages, the customer benefits include low profile and small size. These packages minimize PCB area and maximizes output power.

The LM4916 features circuitry that reduces output transients ("clicks" and "pops") during device turn-on and turn-off, an externally controlled, low-power consumption, active-low shutdown mode, and thermal shutdown. Boomer audio power amplifiers are designed specifically to use few external components and provide high quality output power in a surface mount package.

### Key Specifications

- Mono-BTL output power  
 (R<sub>L</sub> = 8Ω, V<sub>DD</sub> = 1.5V, THD+N = 1%) 85mW (typ)
- Stereo Headphone output power  
 (R<sub>L</sub> = 16Ω, V<sub>DD</sub> = 1.5V, THD+N = 1%) 14mW (typ)
- Micropower shutdown current 0.02μA (typ)
- Supply voltage operating range 0.9V < V<sub>DD</sub> < 2.5V
- PSRR 1kHz, V<sub>DD</sub> = 1.5V 66dB (typ)

### Features

- Single-cell 0.9V to 2.5V battery operation
- BTL mode for mono speaker
- Single ended headphone operation with coupling capacitors
- Unity-gain stable
- "Click and pop" suppression circuitry
- Active low micropower shutdown
- Low current, active-low mute mode
- Thermal shutdown protection circuitry

### Applications

- Portable one-cell audio products
- Portable one-cell electronic devices

### Typical Application

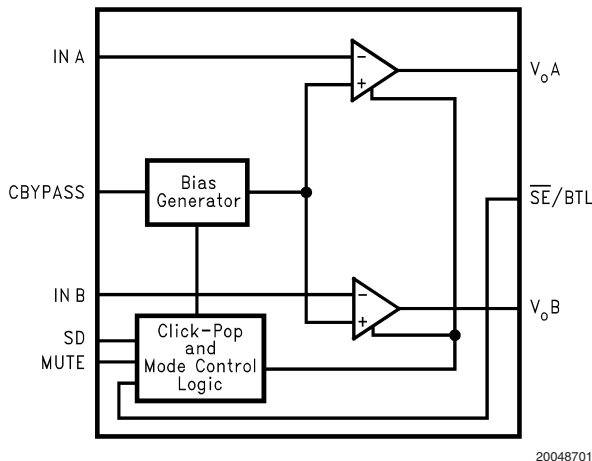
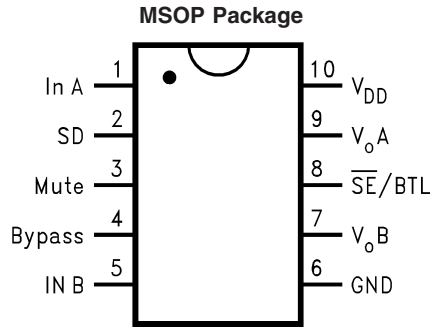

FIGURE 1. Block Diagram

Boomer® is a registered trademark of National Semiconductor Corporation.

# Connection Diagrams



20048702

**Top View**  
**Order Number LM4916MM**  
**See NS Package Number MUB10A for MSOP**

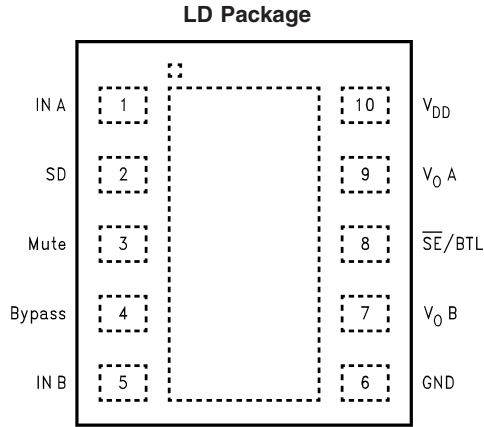

20048752

**Top View**  
**Order Number LM4916LD**  
**See NS Package Number LDA10A**

## MSOP Marking

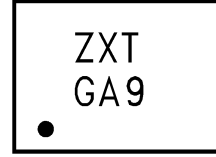

200487F9

**Z - Plant Code**  
**X - Date Code**  
**T - Die Traceability**  
**G - Boomer Family**  
**A9 - LM4916MM**

## LLP Marking

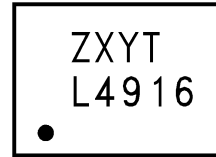

200487G0

**Z - Plant Code**  
**XY - Date Code**  
**T - Die Traceability**  
**Bottom Line - Part Number**

# Typical Connections

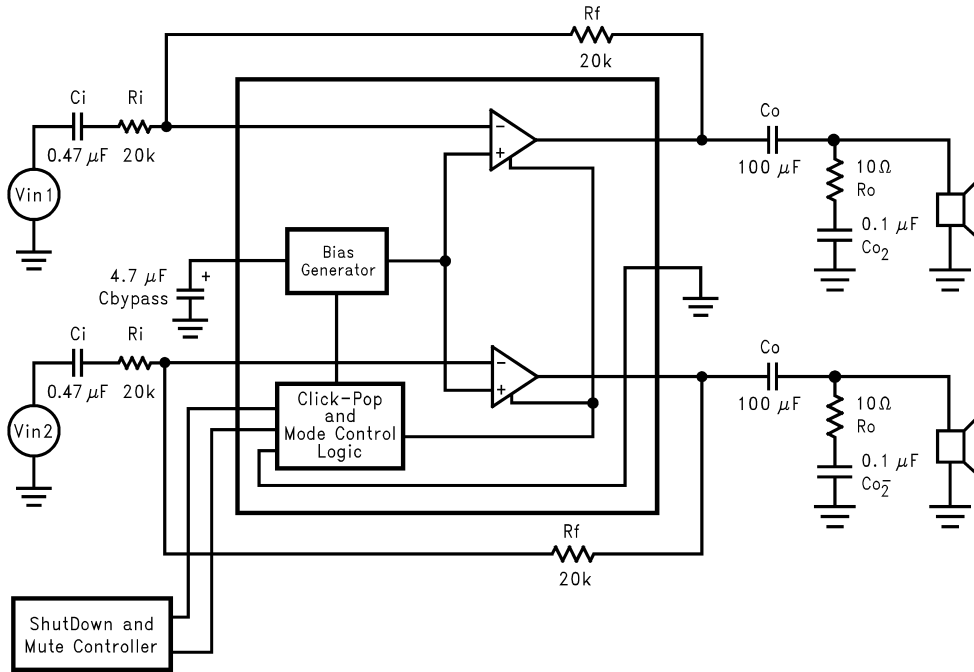

20048703

FIGURE 2. Typical Single Ended Output Configuration Circuit

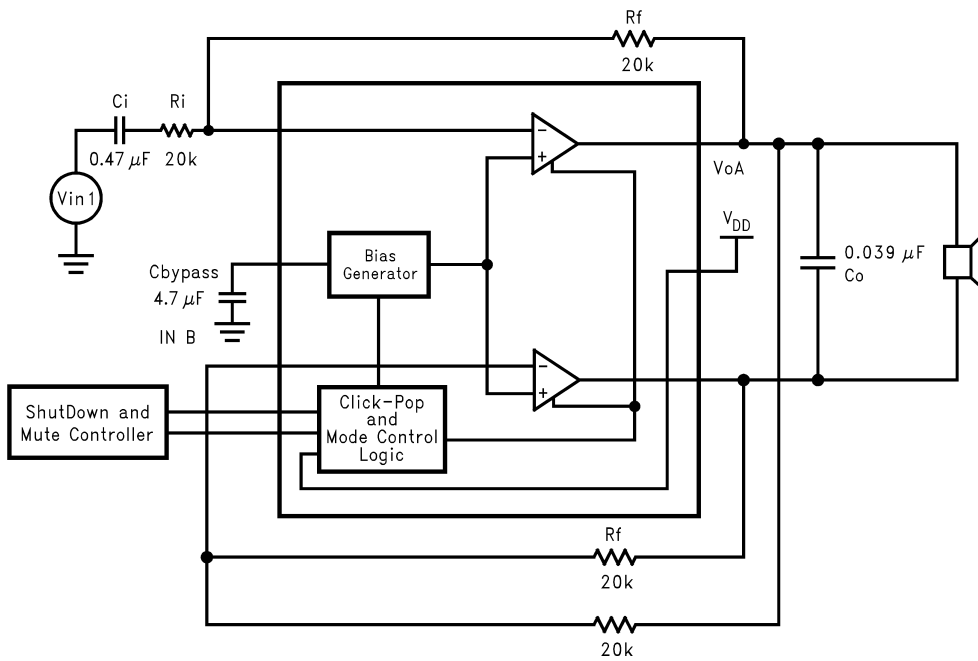

20048705

FIGURE 3. Typical BTL Speaker Configuration Circuit

**Absolute Maximum Ratings** (Note 1)

If Military/Aerospace specified devices are required, please contact the National Semiconductor Sales Office/Distributors for availability and specifications.

Supply Voltage	3.6V
Storage Temperature	-65°C to +150°C
Input Voltage	-0.3V to $V_{DD} + 0.3V$
Power Dissipation (Note 2)	Internally limited
ESD Susceptibility (Note 3)	2000V
ESD Susceptibility (Note 4)	200V
Junction Temperature	150°C
Solder Information	
Small Outline Package Vapor	
Phase (60sec)	215°C

Infrared (15 sec) 220°C

See AN-450 "Surface Mounting and their Effects on Product Reliability" for other methods of soldering surface mount devices.

Thermal Resistance	
$\theta_{JA}$ (typ) MUB10A	175°C/W
$\theta_{JA}$ (typ) LDA10A	73°C/W

**Operating Ratings**

Temperature Range	
$T_{MIN} \leq T_A \leq T_{MAX}$	-40°C $\leq$ $T_A$ $\leq$ 85°C
Supply Voltage (Note 10)	0.9V $\leq$ $V_{DD} \leq$ 2.5V

**Electrical Characteristics for the LM4916** (Notes 1, 5)

The following specifications apply for the circuit shown in Figure 4 operating with  $V_{DD} = 1.5V$ , unless otherwise specified. Limits apply for  $T_A = 25^\circ C$ .

Symbol	Parameter	Conditions	LM4916		Units (Limits)
			Typical (Note 6)	Limit (Note 7)	
$V_{DD}$	Supply Voltage (Notes 10, 11)			0.9	V (min)
				2.5	V (max)
$I_{DD}$	Quiescent Power Supply Current	$V_{IN} = 0V, I_O = 0A, R_L = \infty$ (Note 8)	1.0	1.4	mA (max)
$I_{SD}$	Shutdown Current	$V_{SHUTDOWN} = GND$	0.02		$\mu A$ (max)
$V_{OS}$	Output Offset Voltage	BTL	5	50	mV (max)
$P_O$	Output Power (Note 9)	$f = 1kHz$			
		$R_L = 8\Omega$ BTL, THD+N = 1%	85	70	mW (min)
		$R_L = 16\Omega$ SE, THD+N = 1%	14		mW
THD+N	Total Harmonic Distortion + Noise	$R_L = 8\Omega$ , BTL, $P_O = 25mW$ , $f = 1kHz$	0.1	0.5	%
		$R_L = 16\Omega$ , SE, $P_O = 5mW$ , $f = 1kHz$	0.2		
$V_{NO}$	Output Voltage Noise	20Hz to 20kHz, A-weighted	10		$\mu V_{RMS}$
$I_{MUTE}$	Mute Current	$V_{MUTE} = 0$ , SE	15		$\mu A$
Crosstalk		$R_L = 16\Omega$ , SE	55		dB (min)
PSRR	Power Supply Rejection Ratio	$V_{RIPPLE} = 200mV_{P-P}$ $C_{BYPASS} = 4.7\mu F, R_L = 8\Omega$ $f = 1kHz$ , BTL	62		dB
		$V_{RIPPLE} = 200mV_{P-P}$ sine wave $C_{BYPASS} = 4.7\mu F, R_L = 16\Omega$ $f = 1kHz$ , SE	66		dB (min)
$V_{IH}$	Control Logic High		0.7		V (min)
$V_{IL}$	Control Logic Low		0.3		V (max)

**Note 1:** Absolute Maximum Ratings indicate limits beyond which damage to the device may occur. Operating Ratings indicate conditions for which the device is functional, but do not guarantee specific performance limits. Electrical Characteristics state DC and AC electrical specifications under particular test conditions which guarantee specific performance limits. This assumes that the device is within the Operating Ratings. Specifications are not guaranteed for parameters where no limit is given, however, the typical value is a good indication of device performance.

**Note 2:** The maximum power dissipation is dictated by  $T_{JMAX}$ ,  $\theta_{JA}$ , and the ambient temperature  $T_A$  and must be derated at elevated temperatures. The maximum allowable power dissipation is  $P_{DMAX} = (T_{JMAX} - T_A)/\theta_{JA}$ . For the LM4916,  $T_{JMAX} = 150^\circ\text{C}$ . For the  $\theta_{JAS}$ , please see the Application Information section or the Absolute Maximum Ratings section.

**Note 3:** Human body model, 100pF discharged through a 1.5k $\Omega$  resistor.

**Note 4:** Machine model, 220pF–240pF discharged through all pins.

**Note 5:** All voltages are measured with respect to the ground (GND) pins unless otherwise specified.

**Note 6:** Typical values are measured at 25°C and represent the parametric norm.

**Note 7:** Datasheet min/max specification limits are guaranteed by design, test, or statistical analysis.

**Note 8:** The quiescent power supply current depends on the offset voltage when a practical load is connected to the amplifier.

**Note 9:** Output power is measured at the device terminals.

**Note 10:** When operating on a power supply voltage of 0.9V, the LM4916 will not function below 0°C. At a power supply voltage of 1V or greater, the LM4916 will operate down to -40°C.

**Note 11:** Ripple on power supply line should not exceed 400mV<sub>pp</sub>.

# Typical Performance Characteristics

**THD+N vs Frequency**  
 $V_{DD} = 1.5V, P_O = 5mW, R_L = 16\Omega$   
 BW < 80kHz, Single Ended Output

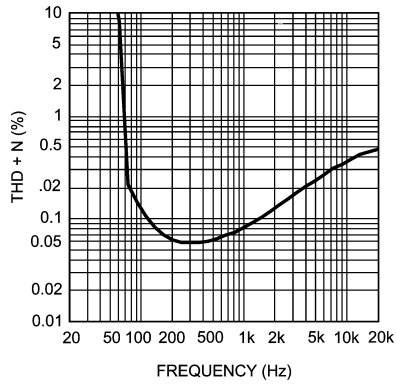

200487C2

**THD+N vs Frequency**  
 $V_{DD} = 1.5V, R_L = 8\Omega, P_O = 25mW$   
 BTL Output,  $A_V = -1$

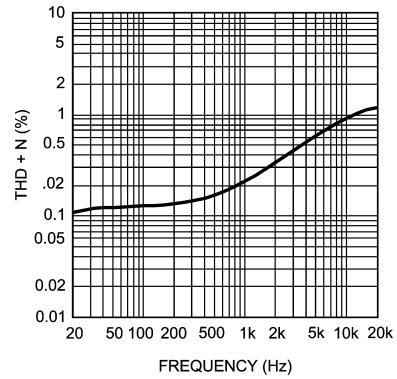

200487D5

**THD+N vs Frequency**  
 $V_{DD} = 1.2V, P_O = 5mW$   
 $R_L = 16\Omega$ , Single Ended Output,  $A_V = -1$

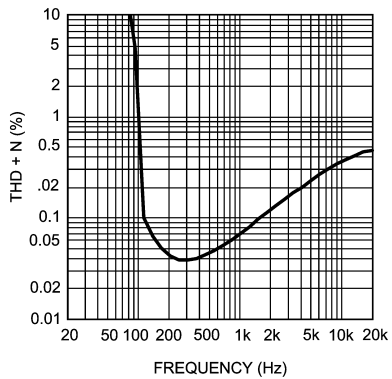

200487D0

**THD+N vs Frequency**  
 $V_{DD} = 1.2V, R_L = 8\Omega, P_O = 25mW$   
 BTL Output,  $A_V = -1$

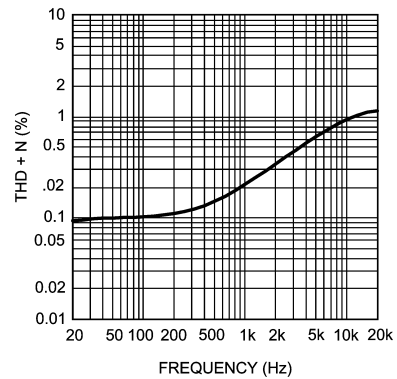

200487D6

**THD+N vs Output Power**  
 $V_{DD} = 1.5V, R_L = 16\Omega, f = 1kHz$   
 Single Ended Output,  $A_V = -1$

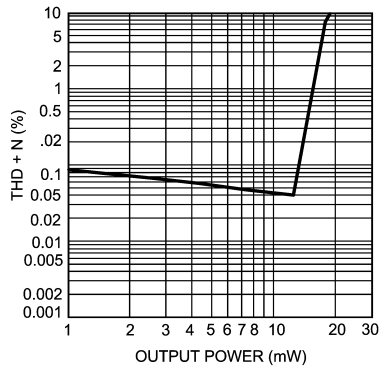

200487D7

**THD+N vs Output Power**  
 $V_{DD} = 1.5V, R_L = 8\Omega, f = 1kHz$   
 BTL Output,  $A_V = -1$

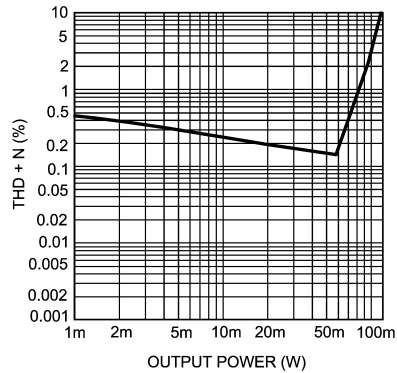

200487D8

Typical Performance Characteristics (Continued)

**THD+N vs Output Power**  
 $V_{DD} = 1.2V, R_L = 16\Omega, f = 1kHz$   
 Single Ended Output,  $A_V = -1$

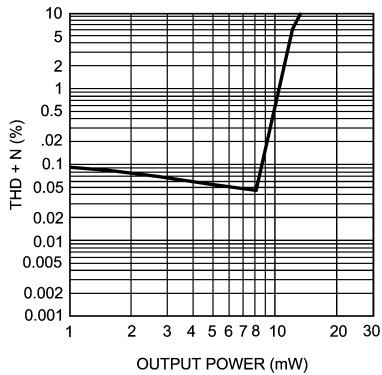

200487E0

**THD+N vs Output Power**  
 $V_{DD} = 1.2V, R_L = 8\Omega, f = 1kHz$   
 BTL Output,  $A_V = -1$

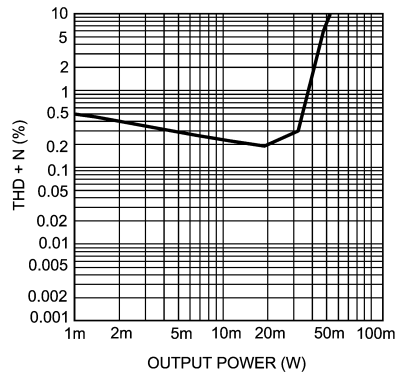

200487D9

**Output Power vs Supply Voltage**  
 $f = 1kHz, R_L = 16\Omega,$   
 Single Ended Output,  $A_V = -1$

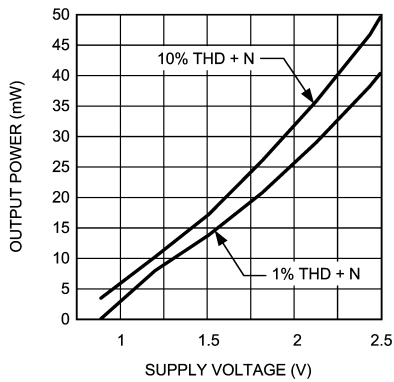

200487G2

**Output Power vs Supply Voltage**  
 $f = 1kHz, R_L = 8\Omega,$   
 BTL Output,  $A_V = -1$

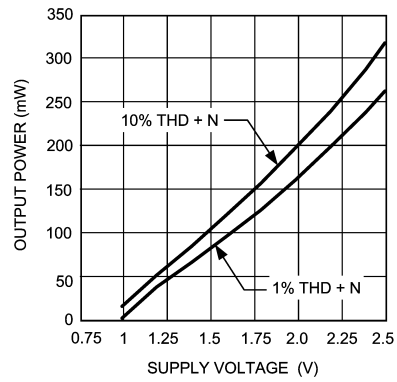

200487G1

**Output Power vs Load Resistance**  
 $V_{DD} = 1.5V, f = 1kHz$   
 Single Ended Output,  $A_V = -1$

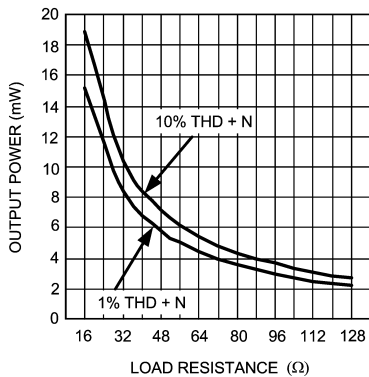

200487E5

**Output Power vs Load Resistance**  
 $V_{DD} = 1.5V, f = 1kHz$   
 BTL Output,  $A_V = -1$

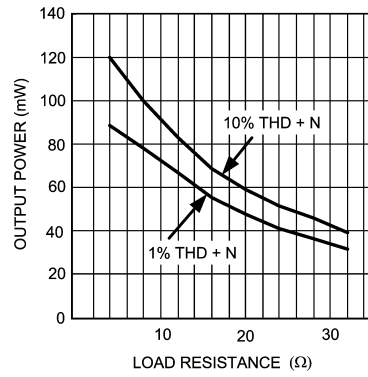

200487E6

# Typical Performance Characteristics (Continued)

**Output Power vs Load Resistance**  
 $V_{DD} = 1.2V, f = 1kHz$   
 Single Ended Output,  $A_V = -1$

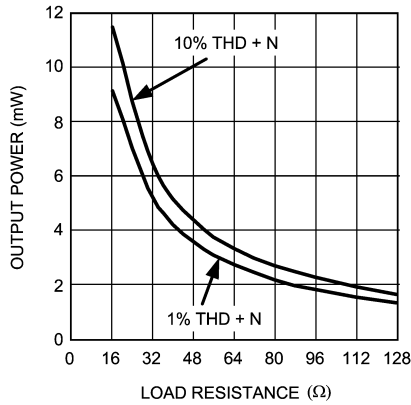

200487E3

**Output Power vs Load Resistance**  
 $V_{DD} = 1.2V, f = 1kHz$   
 BTL Output,  $A_V = -1$

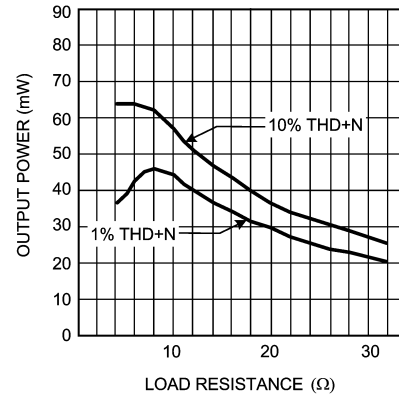

200487E4

**Power Dissipation vs Output Power**  
 $f = 1kHz, THD+N < 1%, A_V = -1$   
 Single Ended Output, Both Channels

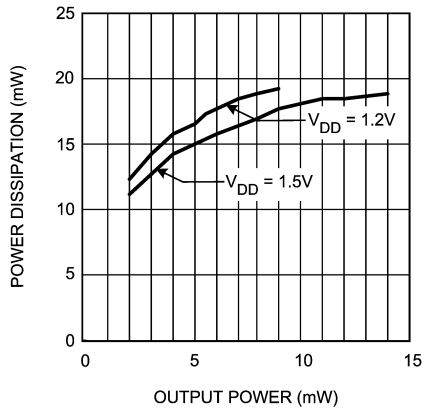

200487F6

**Power Dissipation vs Output Power**  
 $f = 1kHz, THD+N < 1%$   
 BTL Output,  $A_V = -1$

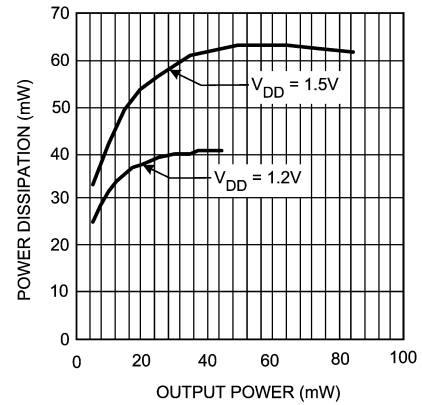

200487F5

**Channel Separation**  
 $R_L = 16Ω, P_O = 5mW$   
 Single Ended Output,  $A_V = -1$

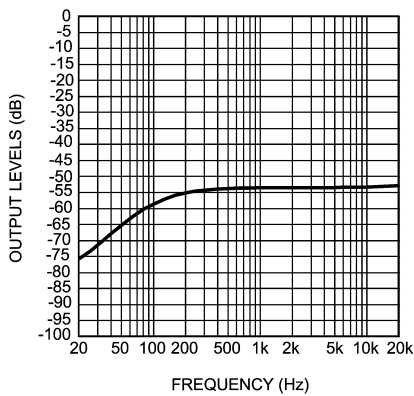

200487D4

**Power Supply Rejection Ratio**  
 $V_{DD} = 1.5V, V_{RIPPLE} = 200mV_{PP}$   
 $R_L = 16Ω, \text{Single Ended Output}$   
 Input Terminated into  $10Ω$

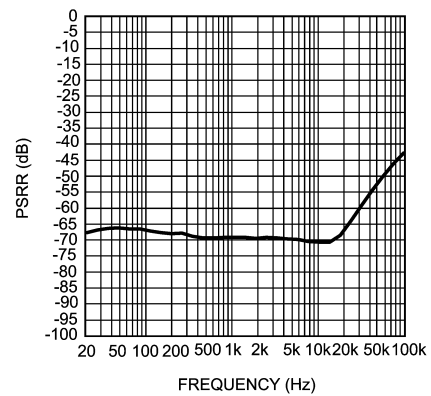

200487C6



Typical Performance Characteristics (Continued)

**Power Supply Rejection Ratio**  
 $V_{DD} = 1.5V$ ,  $V_{RIPPLE} = 200mV_{PP}$   
 $R_L = 8\Omega$ , BTL  
 Input Terminated into  $10\Omega$

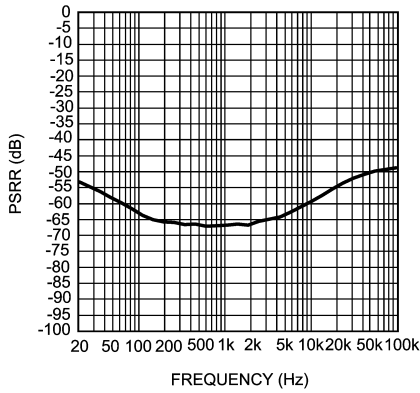

200487C8

**Power Supply Rejection Ratio**  
 $V_{DD} = 1.2V$ ,  $V_{RIPPLE} = 200mV_{PP}$   
 $R_L = 16\Omega$ , Single Ended Output  
 Input Terminated into  $10\Omega$

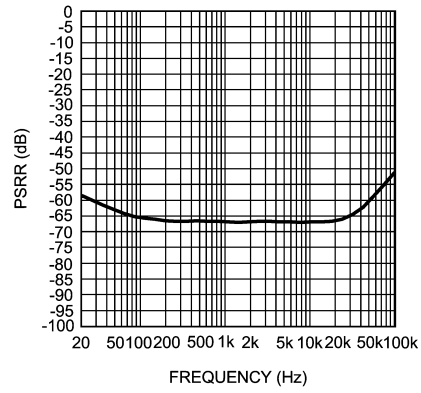

200487C5

**Power Supply Rejection Ratio**  
 $V_{DD} = 1.2V$ ,  $V_{RIPPLE} = 200mV_{PP}$   
 $R_L = 8\Omega$ , BTL  
 Input Terminated into  $10\Omega$

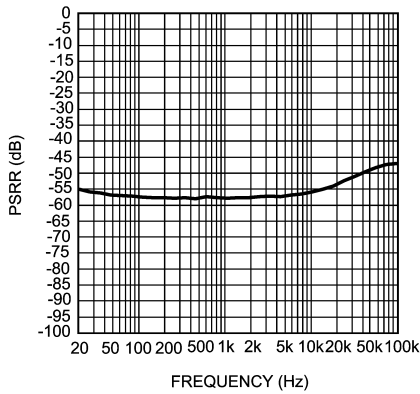

200487C7

**Frequency Response vs Input Capacitor Size**  
 $V_{DD} = 1.5V$ ,  $R_L = 16\Omega$   
 $AV = -1$ ,  $BW < 80kHz$ , Single Ended Output

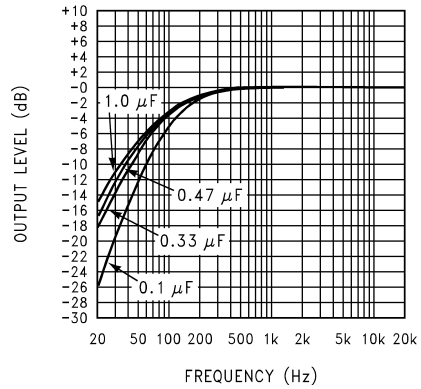

200487F8

**Frequency Response vs Input Capacitor Size**  
 $V_{DD} = 1.5V$ ,  $R_L = 8\Omega$   
 $AV = -1$ ,  $BW < 80kHz$ , BTL Output

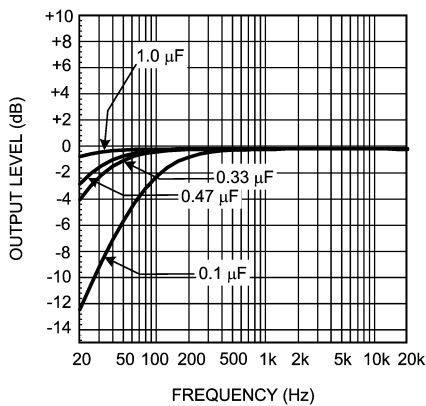

200487C4

**Open Loop Frequency Response**  
 $V_{DD} = 1.5V$ , No load

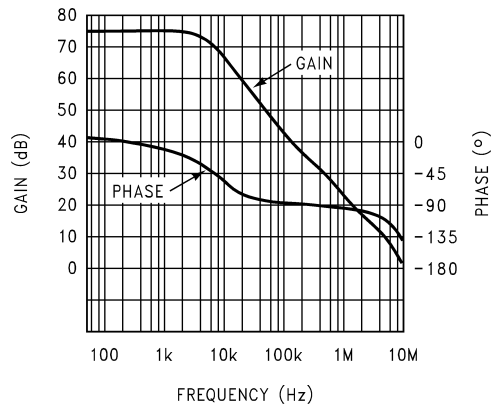

200487B8

# Typical Performance Characteristics (Continued)

**Supply Voltage vs Supply Current**

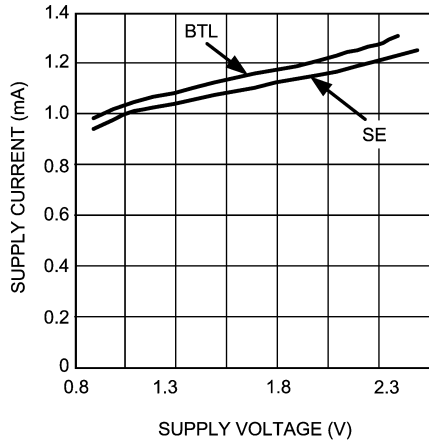

200487F1

**Clipping Voltage vs Supply Voltage**

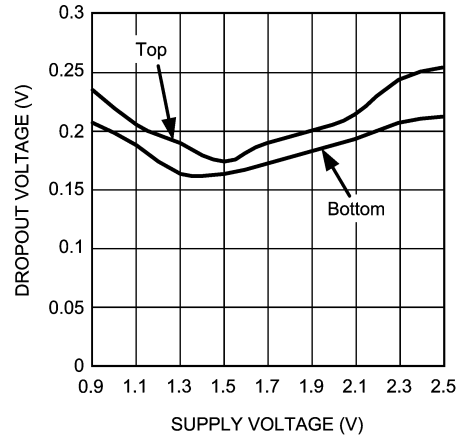

200487E2

**Noise Floor  
V<sub>DD</sub> = 1.5V, Single Ended Output  
16Ω, 80kHz Bandwidth**

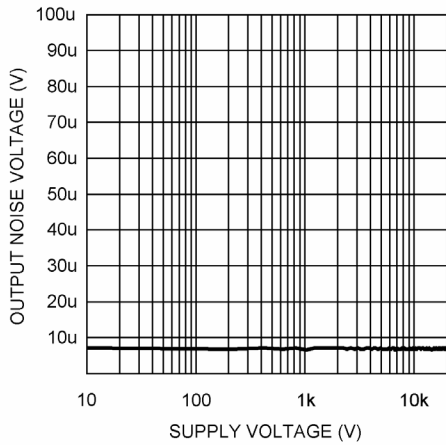

200487B7

**Noise Floor  
V<sub>DD</sub> = 1.5V, BTL Output  
8Ω, 80kHz Bandwidth**

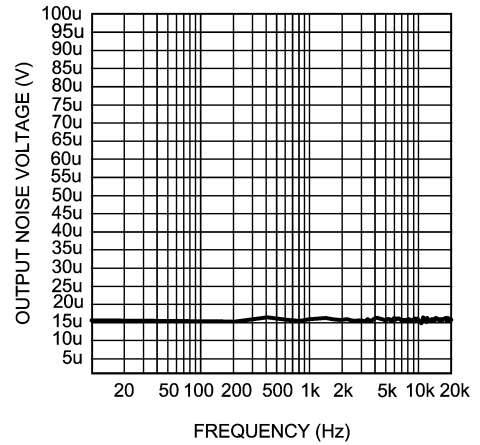

200487C3

**Shutdown Hysteresis Voltage  
V<sub>DD</sub> = 1.5V**

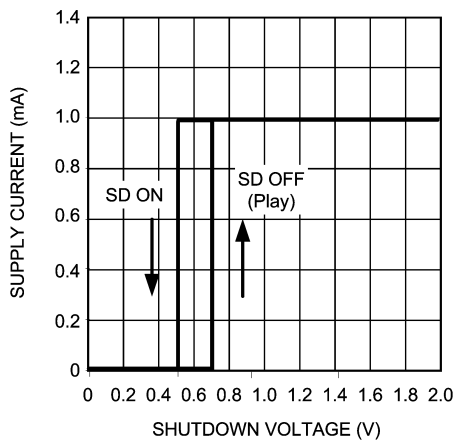

200487E1

**Power Derating Curve  
V<sub>DD</sub> = 1.5V**

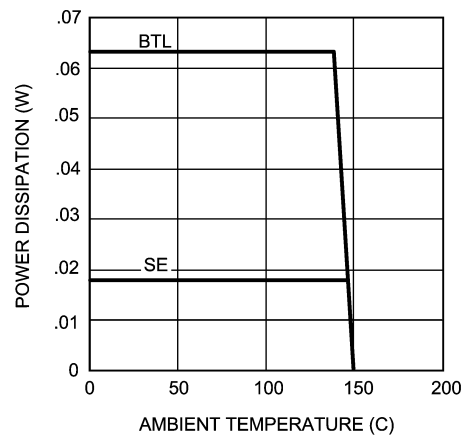

200487F4

## Typical Performance Characteristics (Continued)

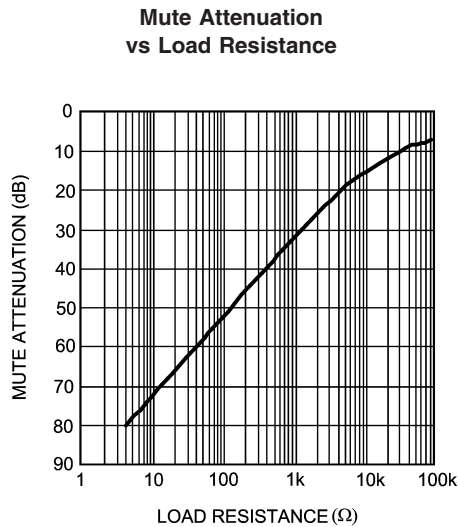

200487F2

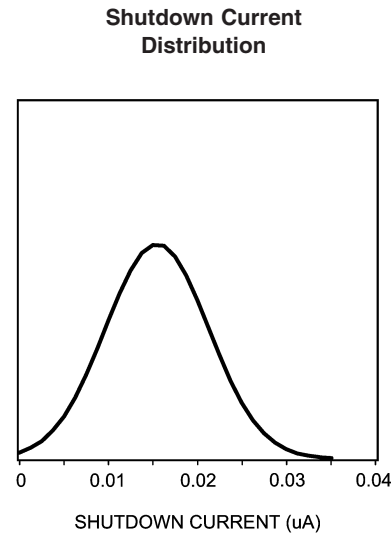

200487F7

## Application Information

### SINGLE ENDED (SE) CONFIGURATION EXPLANATION

As shown in Figure 2, the LM4916 has two operational amplifiers internally, which have externally configurable gain. The closed loop gain of the two configurable amplifiers is set by selecting the ratio of  $R_f$  to  $R_i$ . Consequently, the gain for each channel of the IC is

$$A_{VD} = -(R_f / R_i)$$

When the LM4916 operates in Single Ended mode, coupling capacitors are used on each output ( $V_{oA}$  and  $V_{oB}$ ) and the SE/BTL pin (Pin 8) is connected to ground. These output coupling capacitors blocks the half supply voltage to which the output amplifiers are typically biased and couples the audio signal to the headphones or other single-ended (SE) loads. The signal return to circuit ground is through the headphone jack's sleeve.

### BRIDGED (BTL) CONFIGURATION EXPLANATION

As shown in Figure 3, the LM4916 has two internal operational amplifiers. The first amplifier's gain is externally configurable, while the second amplifier should be externally fixed in a unity-gain, inverting configuration. The closed-loop gain of the first amplifier is set by selecting the ratio of  $R_f$  to  $R_i$ , while the second amplifier's gain should be fixed by the two external 20kΩ resistors. Figure 3 shows that the output of amplifier one serves as the input to amplifier two which results in both amplifiers producing signals identical in magnitude, but out of phase by 180°. Consequently, the differential gain for the IC is

$$A_{VD} = 2 * (R_f / R_i).$$

By driving the load differentially through outputs  $V_{o1}$  and  $V_{o2}$ , an amplifier configuration commonly referred to as "bridged mode" is established. Bridged mode operation is different from the classical single-ended amplifier configuration where one side of the load is connected to ground. A

bridge amplifier design has a few distinct advantages over the single-ended configuration. It provides a differential drive to the load, thus doubling output swing for a specified supply voltage. Four times the output power is possible as compared to a single-ended amplifier under the same conditions. This increase in attainable output power assumes that the amplifier is not current limited or clipped. In order to choose an amplifier's closed-loop gain without causing excessive clipping, please refer to the Audio Power Amplifier Design section.

A bridge configuration, such as the one used in LM4916, also creates a second advantage over single-ended amplifiers. Since the differential outputs,  $V_{o1}$  and  $V_{o2}$ , are biased at half-supply, no net DC voltage exists across the load. This eliminates the need for an output coupling capacitor which is required in a single supply, single-ended amplifier configuration.

### MODE SELECT DETAIL

The LM4916 can be configured in either Single Ended or BTL mode (see Figure 2 and Figure 3). The default state of the LM4916 at power up is single ended. During initial power up or return from shutdown, the LM4916 must detect the correct mode of operation by sensing the status of the SE/BTL pin. When the bias voltage of the part ramps up to 60mV (as seen on the Bypass pin), an internal comparator detects the status of SE/BTL; and at 10mV, latches that value in place. Ramp up of the bias voltage will proceed at a different rate from this point on depending upon operating mode. BTL mode will ramp up about 11 times faster than Single Ended mode. Shutdown is not a valid command during this time period ( $T_{WU}$ ) and should not be enabled to ensure a proper power on reset (POR) signal. In addition, the slew rate of  $V_{DD}$  must be greater than 2.5V/ms to ensure reliable POR. Recommended power up timing is shown in Figure 5 along with proper usage of Shutdown and Mute. The mode-select circuit is suspended during  $C_B$  discharge time. The circuit shown in Figure 4 presents an applications solution to the problem of using different supply voltages with different turn-on times in a system with the LM4916. This circuit shows the LM4916 with a 25-50kΩ. Pull-up resistor connected from the shutdown pin to  $V_{DD}$ . The shut-

## Application Information (Continued)

down pin of the LM4916 is also being driven by an open drain output of an external microcontroller on a separate supply. This circuit ensures that shutdown is disabled when powering up the LM4916 by either allowing shutdown to be high before the LM4916 powers on (the microcontroller pow-

ers up first) or allows shutdown to ramp up with  $V_{DD}$  (the LM4916 powers up first). This will ensure the LM4916 powers up properly and enters the correct mode of operation. Please note that the  $\overline{SE}/BTL$  pin (Pin 8) should be tied to GND for Single Ended mode, and to  $V_{DD}$  for BTL mode.

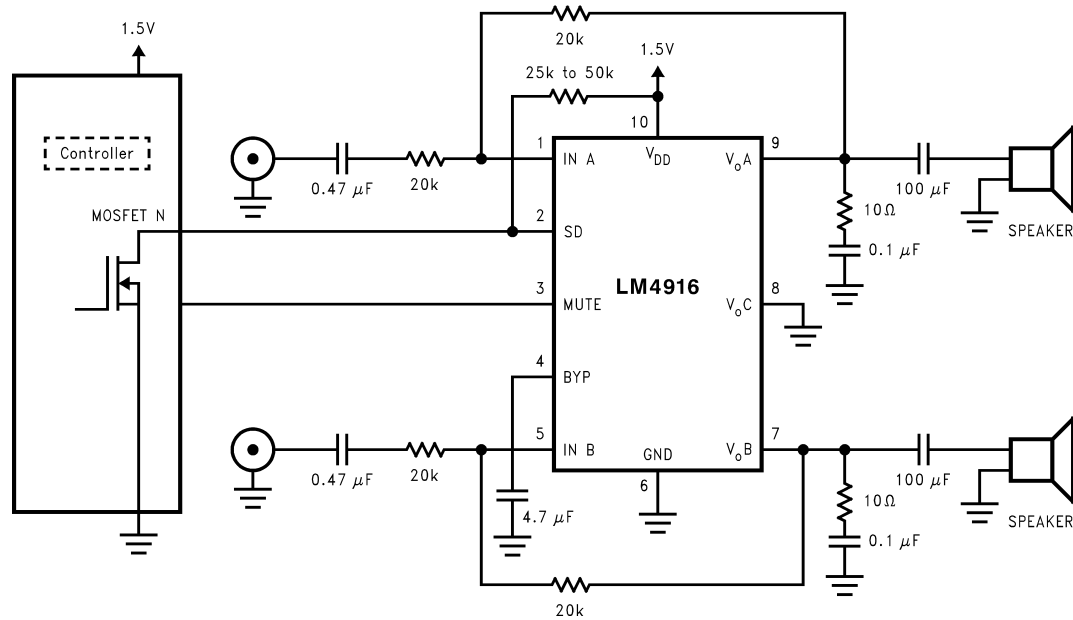

20048753

FIGURE 4. Recommended Circuit for Different Supply Turn-On Timing

## Application Information (Continued)

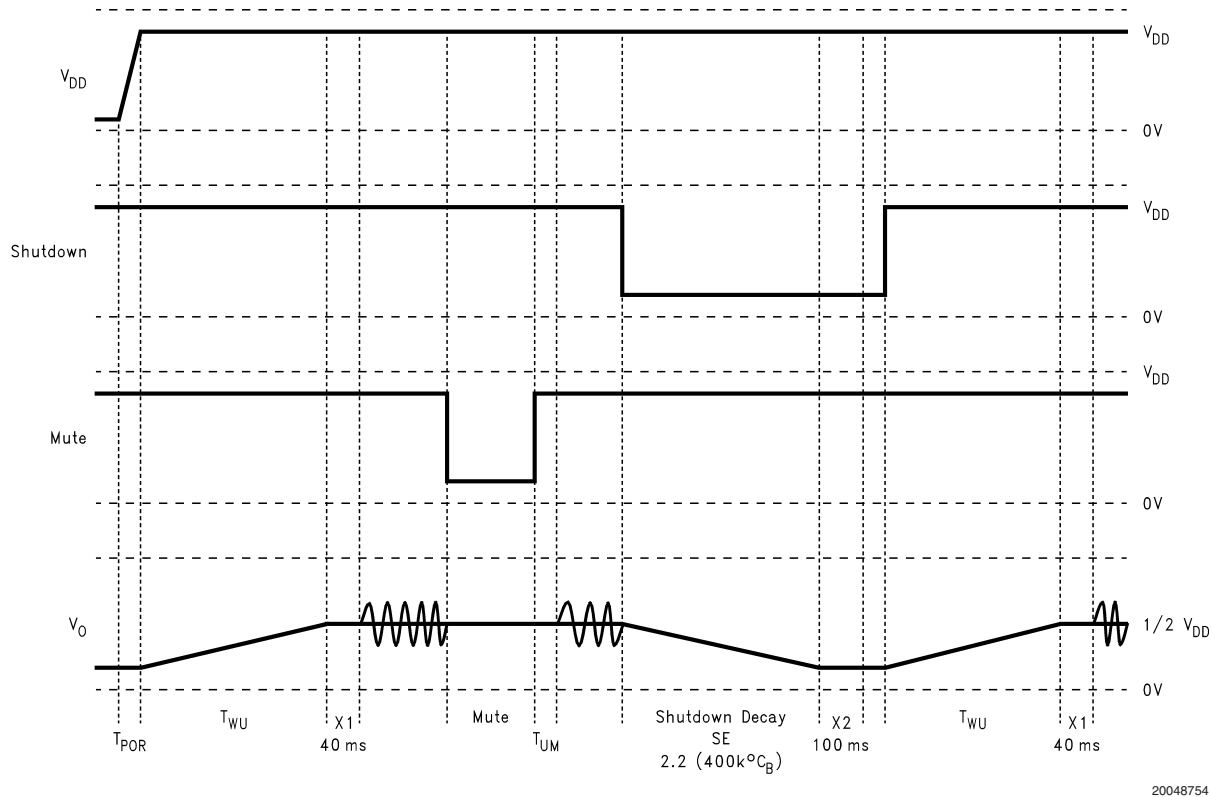

FIGURE 5. Turn-On, Shutdown, and Mute Timing for Cap-Coupled Mode

### POWER DISSIPATION

Power dissipation is a major concern when designing a successful amplifier, whether the amplifier is bridged or single-ended. A direct consequence of the increased power delivered to the load by a bridge amplifier is an increase in internal power dissipation. Since the LM4916 has two operational amplifiers in one package, the maximum internal power dissipation is 4 times that of a single-ended amplifier. The maximum power dissipation for a given BTL application can be derived from the power dissipation graphs or from Equation 1.

$$P_{DMAX} = 4 \cdot (V_{DD})^2 / (2\pi^2 R_L) \quad (1)$$

When operating in Single Ended mode, Equation 2 states the maximum power dissipation point for a single-ended amplifier operating at a given supply voltage and driving a specified output load.

$$P_{DMAX} = (V_{DD})^2 / (2\pi^2 R_L) \quad (2)$$

Since the LM4916 has two operational amplifiers in one package, the maximum internal power dissipation point is twice that of the number that results from Equation 2. From Equation 2, assuming a 1.5V power supply and a 16Ω load, the maximum power dissipation point is 7mW per amplifier. Thus the maximum package dissipation point is 14mW.

The maximum power dissipation point obtained from either Equations 1, 2 must not be greater than the power dissipation that results from Equation 3:

$$P_{DMAX} = (T_{JMAX} - T_A) / \theta_{JA} \quad (3)$$

For package MUB10A,  $\theta_{JA} = 175^\circ\text{C/W}$ .  $T_{JMAX} = 150^\circ\text{C}$  for the LM4916. Depending on the ambient temperature,  $T_A$ , of the system surroundings, Equation 3 can be used to find the maximum internal power dissipation supported by the IC packaging. If the result of Equation 1 or 2 is greater than that of Equation 3, then either the supply voltage must be decreased, the load impedance increased or  $T_A$  reduced. For the typical application of a 1.5V power supply, with a 16Ω load, the maximum ambient temperature possible without violating the maximum junction temperature is approximately  $146^\circ\text{C}$  provided that device operation is around the maximum power dissipation point. Thus, for typical applications, power dissipation is not an issue. Power dissipation is a function of output power and thus, if typical operation is not around the maximum power dissipation point, the ambient temperature may be increased accordingly. Refer to the Typical Performance Characteristics curves for power dissipation information for lower output powers.

## Application Information (Continued)

### EXPOSED-DAP PACKAGE PCB MOUNTING CONSIDERATIONS

The LM4916's exposed-DAP (die attach paddle) package (LD) provides a low thermal resistance between the die and the PCB to which the part is mounted and soldered. This allows rapid heat transfer from the die to the surrounding PCB copper traces, ground plane, and surrounding air.

The LD package should have its DAP soldered to a copper pad on the PCB. The DAP's PCB copper pad may be connected to a large plane of continuous unbroken copper. This plane forms a thermal mass, heat sink, and radiation area. Further detailed and specific information concerning PCB layout, fabrication, and mounting an LD (LLP) package is available from National Semiconductor's Package Engineering Group under application note AN1187.

### POWER SUPPLY BYPASSING

As with any amplifier, proper supply bypassing is important for low noise performance and high power supply rejection. The capacitor location on the power supply pins should be as close to the device as possible. Typical applications employ a battery (or 1.5V regulator) with 10 $\mu$ F tantalum or electrolytic capacitor and a ceramic bypass capacitor that aid in supply stability. This does not eliminate the need for bypassing the supply nodes of the LM4916. A bypass capacitor value in the range of 0.1 $\mu$ F to 1 $\mu$ F is recommended.

### MICRO POWER SHUTDOWN

The voltage applied to the SHUTDOWN pin controls the LM4916's shutdown function. Activate micro-power shutdown by applying a logic-low voltage to the SHUTDOWN pin. When active, the LM4916's micro-power shutdown feature turns off the amplifier's bias circuitry, reducing the supply current. The trigger point varies depending on supply voltage and is shown in the Shutdown Hysteresis Voltage graphs in the Typical Performance Characteristics section. The low 0.02 $\mu$ A (typ) shutdown current is achieved by applying a voltage that is as near as ground as possible to the SHUTDOWN pin. A voltage that is higher than ground may increase the shutdown current. There are a few ways to control the micro-power shutdown. These include using a single-pole, single-throw switch, a microprocessor, or a microcontroller. When using a switch, connect an external 100k $\Omega$  pull-up resistor between the SHUTDOWN pin and V<sub>DD</sub>. Connect the switch between the SHUTDOWN pin and ground. Select normal amplifier operation by opening the switch. Closing the switch connects the SHUTDOWN pin to ground, activating micro-power shutdown. The switch and resistor guarantee that the SHUTDOWN pin will not float. This prevents unwanted state changes. In a system with a microprocessor or microcontroller, use a digital output to apply the control voltage to the SHUTDOWN pin. Driving the SHUTDOWN pin with active circuitry eliminates the pull-up resistor.

### MUTE

When in single ended mode, the LM4916 also features a mute function that enables extremely fast turn-on/turn-off with a minimum of output pop and click with a low current consumption ( $\leq 20\mu$ A, typical). The mute function leaves the outputs at their bias level, thus resulting in higher power consumption than shutdown mode, but also provides much faster turn on/off times. Providing a logic low signal on the MUTE pin enables mute mode. Threshold voltages and ac-

tivation techniques match those given for the shutdown function as well. Mute may not appear to function when the LM4916 is used to drive high impedance loads. This is because the LM4916 relies on a typical headphone load (16-32 $\Omega$ ) to reduce input signal feed-through through the input and feedback resistors. Mute attenuation can thus be calculated by the following formula:

$$\text{Mute Attenuation (dB)} = 20\text{Log}[R_L / (R_i + R_f)]$$

Parallel load resistance may be necessary to achieve satisfactory mute levels when the application load is known to be high impedance. The mute function, described above, is not necessary when the LM4916 is operating in BTL mode since the shutdown function operates quickly in BTL mode with less power consumption than mute. In these modes, the Mute signal is equivalent to the Shutdown signal. Mute may be enabled during shutdown transitions, but should not be toggled for a brief period immediately after exiting or entering shutdown. These brief time periods are labeled X1 (time after returning from shutdown) and X2 (time after entering shutdown) and are shown in the timing diagram given in Figure 5. X1 occurs immediately following a return from shutdown (TWU) and lasts 40ms $\pm$ 25%. X2 occurs after the part is placed in shutdown and the decay of the bias voltage has occurred (2.2\*250k\*CB) and lasts for 100ms $\pm$ 25%. The timing of these transition periods relative to X1 and X2 is also shown in Figure 5. While in single ended mode, mute should not be toggled during these time periods, but may be toggled during the shutdown transitions or any other time the part is in normal operation. Failure to operate mute correctly may result in much higher click and pop values or failure of the device to mute at all.

### PROPER SELECTION OF EXTERNAL COMPONENTS

Proper selection of external components in applications using integrated power amplifiers is critical to optimize device and system performance. While the LM4916 is tolerant of external component combinations, consideration to component values must be used to maximize overall system quality. The LM4916 is unity-gain stable that gives the designer maximum system flexibility. The LM4916 should be used in low gain configurations to minimize THD+N values, and maximize the signal to noise ratio. Low gain configurations require large input signals to obtain a given output power. Input signals equal to or greater than 1V<sub>rms</sub> are available from sources such as audio codecs. Very large values should not be used for the gain-setting resistors. Values for R<sub>i</sub> and R<sub>f</sub> should be less than 1M $\Omega$ . Please refer to the section, Audio Power Amplifier Design, for a more complete explanation of proper gain selection. Besides gain, one of the major considerations is the closed-loop bandwidth of the amplifier. To a large extent, the bandwidth is dictated by the choice of external components shown in Figures 2 and 3. The input coupling capacitor, C<sub>i</sub>, forms a first order high pass filter that limits low frequency response. This value should be chosen based on needed frequency response and turn-on time.

### SELECTION OF INPUT CAPACITOR SIZE

Amplifying the lowest audio frequencies requires a high value input coupling capacitor, C<sub>i</sub>. A high value capacitor can be expensive and may compromise space efficiency in portable designs. In many cases, however, the headphones used in portable systems have little ability to reproduce signals below 60Hz. Applications using headphones with this

## Application Information (Continued)

limited frequency response reap little improvement by using a high value input capacitor. In addition to system cost and size, turn on time is affected by the size of the input coupling capacitor  $C_i$ . A larger input coupling capacitor requires more charge to reach its quiescent DC voltage. This charge comes from the output via the feedback. Thus, by minimizing the capacitor size based on necessary low frequency response, turn-on time can be minimized. A small value of  $C_i$  (in the range of  $0.1\mu\text{F}$  to  $0.47\mu\text{F}$ ), is recommended.

### Bypass Capacitor Value Selection

Besides minimizing the input capacitor size, careful consideration should be paid to value of  $C_B$ , the capacitor connected to the BYPASS pin. Since  $C_B$  determines how fast the LM4916 settles to quiescent operation, its value is critical when minimizing turn-on pops. The slower the LM4916's outputs ramp to their quiescent DC voltage (nominally  $V_{DD}/2$ ), the smaller the turn-on pop. Choosing  $C_B$  equal to  $4.7\mu\text{F}$  along with a small value of  $C_i$  (in the range of  $0.1\mu\text{F}$  to  $0.47\mu\text{F}$ ), produces a click-less and pop-less shutdown function. As discussed above, choosing  $C_i$  no larger than necessary for the desired bandwidth helps minimize clicks and pops. This ensures that output transients are eliminated when power is first applied or the LM4916 resumes operation after shutdown.

### Minimizing External Components

Operating the LM4916 at higher gain settings can minimize the use of external components. For instance, a BTL configuration with a gain setting greater than  $8\text{V/V}$  ( $A_V > 8$ ) makes the output capacitor  $C_O$  unnecessary. For the Single Ended configuration, a gain setting greater than  $4\text{V/V}$  ( $A_V > 4$ ) eliminates the need for output capacitor  $C_{O2}$  and output resistor  $R_O$ , on each output channel.

If the LM4916 is operating with a lower gain setting ( $A_V < 4$ ), external components can be further minimized only in Single Ended mode. For each channel, output capacitor ( $C_{O2}$ ) and output resistor ( $R_O$ ) can be eliminated. These components need to be compensated for by adding a  $7.5\text{k}\Omega$  resistor ( $R_C$ ) between the input pin and ground pin on each channel (between Pin 1 and GND, and between Pin 5 and GND).

### OPTIMIZING CLICK AND POP REDUCTION PERFORMANCE

The LM4916 contains circuitry that eliminates turn-on and shutdown transients ("clicks and pops"). For this discussion, turn-on refers to either applying the power supply voltage or when the micro-power shutdown mode is deactivated.

As the  $V_{DD}/2$  voltage present at the BYPASS pin ramps to its final value, the LM4916's internal amplifiers are configured as unity gain buffers. An internal current source charges the capacitor connected between the BYPASS pin and GND in a controlled, linear manner. Ideally, the input and outputs track the voltage applied to the BYPASS pin. The gain of the internal amplifiers remains unity until the voltage on the bypass pin reaches  $V_{DD}/2$ . As soon as the voltage on the bypass pin is stable, the device becomes fully operational and the amplifier outputs are reconnected to their respective output pins. Although the BYPASS pin current cannot be modified, changing the size of  $C_B$  alters the device's turn-on time. There is a linear relationship between the size of  $C_B$  and the turn-on time. Here are some typical turn-on times for various values of  $C_B$ :

#### Single-Ended

$C_B(\mu\text{F})$	$T_{ON}$
0.1	117ms
0.22	179ms
0.47	310ms
1.0	552ms
2.2	1.14s
4.7	2.4s

#### BTL

$C_B(\mu\text{F})$	$T_{ON}$ (ms)
0.1	72
0.22	79
0.47	89
1.0	112
2.2	163
4.7	283

In order to eliminate "clicks and pops", all capacitors must be discharged before turn-on. Rapidly switching  $V_{DD}$  may not allow the capacitors to fully discharge, which may cause "clicks and pops".

## AUDIO POWER AMPLIFIER DESIGN

### A 25mW/32 $\Omega$ Audio Amplifier

Given:

Power Output	10mWrms
Load Impedance	16 $\Omega$
Input Level	0.4Vrms
Input Impedance	20k $\Omega$

A designer must first choose a mode of operation (SE or BTL) and determine the minimum supply rail to obtain the specified output power. By extrapolating from the Output Power vs. Supply Voltage graphs in the Typical Performance Characteristics section, the supply rail can be easily found. 1.5V is a standard voltage in most applications, it is chosen for the supply rail. Extra supply voltage creates headroom that allows the LM4916 to reproduce peak in excess of 10mW without producing audible distortion. At this time, the designer must make sure that the power supply choice along with the output impedance does not violate the conditions explained in the Power Dissipation section. Once the power dissipation equations have been addressed, the required gain can be determined from Equation 2.

$$A_V \geq \sqrt{(P_O R_L)/(V_{IN})} = V_{orms}/V_{inrms} \quad (4)$$

From Equation 4, the minimum AV is 1; use  $A_V = 1$ . Since the desired input impedance is 20k, and with a  $A_V$  gain of 1, a ratio of 1:1 results from Equation 1 for  $R_i$  to  $R$ . The values are chosen with  $R_i = 20\text{k}$  and  $R_f = 20\text{k}$ . The final design step is to address the bandwidth requirements which must be stated as a pair of -3dB frequency points. Five times away from a -3dB point is 0.17dB down from passband response which is better than the required  $\pm 0.25\text{dB}$  specified.

## Application Information (Continued)

$$f_L = 100\text{Hz}/5 = 20\text{Hz}$$

$$f_H = 20\text{kHz} * 5 = 100\text{kHz}$$

As stated in the **External Components** section,  $R_i$  in conjunction with  $C_i$  creates a

$$C_i \geq 1 / (2\pi * 20\text{k}\Omega * 20\text{Hz}) = 0.397\mu\text{F}; \text{ use } 0.39\mu\text{F}.$$

The high frequency pole is determined by the product of the desired frequency pole,  $f_H$ , and the differential gain,  $A_V$ . With an  $A_V = 1$  and  $f_H = 100\text{kHz}$ , the resulting GBWP =  $100\text{kHz}$  which is much smaller than the LM4916 GBWP of  $3\text{MHz}$ . This example displays that if a designer has a need to design an amplifier with higher differential gain, the LM4916 can still be used without running into bandwidth limitations.



## Revision History

Rev	Date	Description
1.0	7/11/03	Re-released the D/S to the WEB.
1.1	7/25/06	Deleted the RL labels on curves E5, E6, E3, and E4, per Allan S., then re-released the D/S to the WEB.

# Physical Dimensions inches (millimeters)

unless otherwise noted

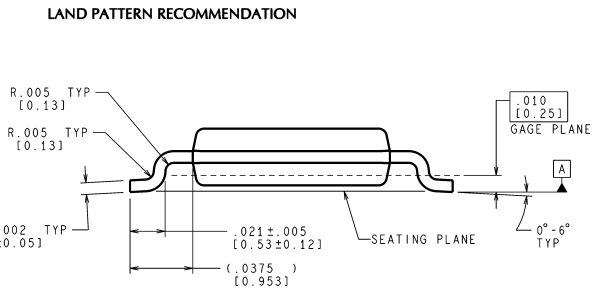
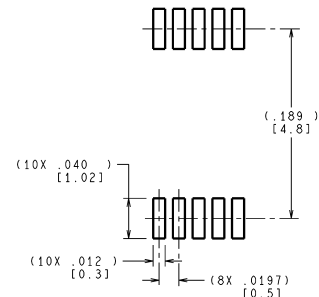
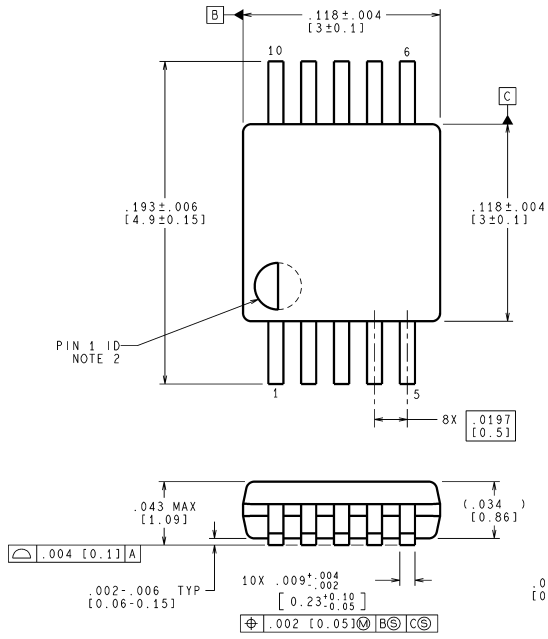

CONTROLLING DIMENSION IS INCH  
VALUES IN [ ] ARE MILLIMETERS  
DIMENSIONS IN ( ) FOR REFERENCE ONLY

MUB10A (Rev B)

**MSOP Package**  
**Order Number LM4916MM**  
**NS Package Number MUB10A**

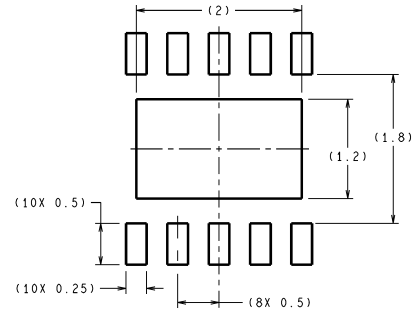

DIMENSIONS ARE IN MILLIMETERS

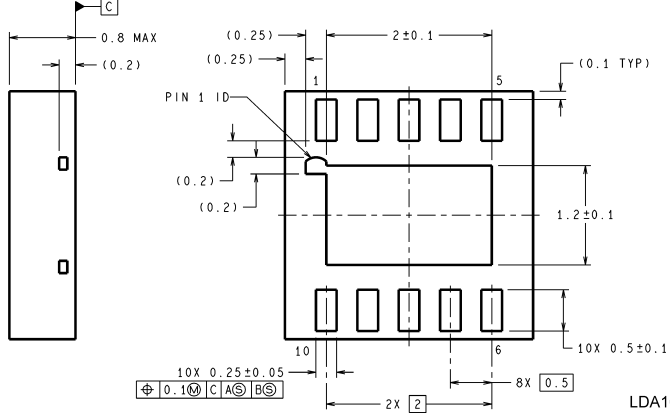
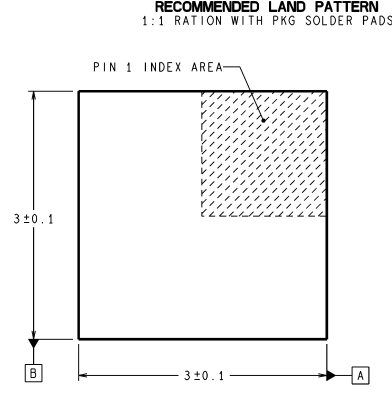

LDA10A (Rev B)

**LD Package**  
**Order Number LM4916LD**  
**NS Package Number LDA10A**

## Notes

National does not assume any responsibility for use of any circuitry described, no circuit patent licenses are implied and National reserves the right at any time without notice to change said circuitry and specifications.  
 For the most current product information visit us at [www.national.com](http://www.national.com).

### LIFE SUPPORT POLICY

NATIONAL'S PRODUCTS ARE NOT AUTHORIZED FOR USE AS CRITICAL COMPONENTS IN LIFE SUPPORT DEVICES OR SYSTEMS WITHOUT THE EXPRESS WRITTEN APPROVAL OF THE PRESIDENT AND GENERAL COUNSEL OF NATIONAL SEMICONDUCTOR CORPORATION. As used herein:

- |  |   |
|--|---|
| <p>1. Life support devices or systems are devices or systems which, (a) are intended for surgical implant into the body, or (b) support or sustain life, and whose failure to perform when properly used in accordance with instructions for use provided in the labeling, can be reasonably expected to result in a significant injury to the user.</p> | <p>2. A critical component is any component of a life support device or system whose failure to perform can be reasonably expected to cause the failure of the life support device or system, or to affect its safety or effectiveness.</p> |
|--|---|

### BANNED SUBSTANCE COMPLIANCE

National Semiconductor follows the provisions of the Product Stewardship Guide for Customers (CSP-9-111C2) and Banned Substances and Materials of Interest Specification (CSP-9-111S2) for regulatory environmental compliance. Details may be found at: [www.national.com/quality/green](http://www.national.com/quality/green).

Lead free products are RoHS compliant.



**National Semiconductor**  
**Americas Customer**  
**Support Center**  
 Email: [new.feedback@nsc.com](mailto:new.feedback@nsc.com)  
 Tel: 1-800-272-9959

**National Semiconductor**  
**Europe Customer Support Center**  
 Fax: +49 (0) 180-530 85 86  
 Email: [europe.support@nsc.com](mailto:europe.support@nsc.com)  
 Deutsch Tel: +49 (0) 69 9508 6208  
 English Tel: +44 (0) 870 24 0 2171  
 Français Tel: +33 (0) 1 41 91 8790

**National Semiconductor**  
**Asia Pacific Customer**  
**Support Center**  
 Email: [ap.support@nsc.com](mailto:ap.support@nsc.com)

**National Semiconductor**  
**Japan Customer Support Center**  
 Fax: 81-3-5639-7507  
 Email: [jpn.feedback@nsc.com](mailto:jpn.feedback@nsc.com)  
 Tel: 81-3-5639-7560