

# FZT790A

## PNP Low Saturation Transistor

- These devices are designed with high current gain and low saturation voltage with collector currents up to 3A continuous.

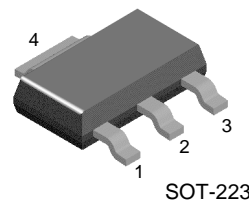

SOT-223

1. Base 2. Collector 3. Emitter

## Absolute Maximum Ratings \* $T_C=25^\circ\text{C}$ unless otherwise noted

Symbol	Parameter	Value	Units
$V_{CEO}$	Collector-Emitter Voltage	-40	V
$V_{CBO}$	Collector-Base Voltage	-50	V
$V_{EBO}$	Emitter-Base Voltage	-5	V
$I_C$	Collector Current - Continuous	-3	A
$T_J, T_{STG}$	Operating and Storage Junction Temperature Range	-55 ~ +150	$^\circ\text{C}$

\* These ratings are limiting values above which the serviceability of any semiconductor device may be impaired.

### NOTES:

1. These ratings are based on a maximum junction temperature of 150degrees C.
2. These are steady state limits. The factory should be consulted on applications involving pulsed or low duty cycle operations.

## Electrical Characteristics $T_A=25^\circ\text{C}$ unless otherwise noted

Symbol	Parameter	Test Conditions	Min.	Max.	Units
<b>Off Characteristics</b>					
$BV_{CEO}$	Collector-Emitter Breakdown Voltage	$I_C = -10\text{mA}, I_B = 0$	-40		V
$BV_{CBO}$	Collector-Base Breakdown Voltage	$I_C = -100\mu\text{A}, I_E = 0$	-50		V
$BV_{EBO}$	Emitter-Base Breakdown Voltage	$I_E = -100\mu\text{A}, I_C = 0$	-5.0		V
$I_{CBO}$	Collector Cut-off Current	$V_{CB} = -30\text{V}, I_E = 0$ $V_{CB} = -30\text{V}, I_E = 0, T_A = 100^\circ\text{C}$		-100 -10	nA $\mu\text{A}$
$I_{EBO}$	Emitter Cut-off Current	$V_{EB} = -4\text{V}, I_C = 0$		-100	nA
<b>On Characteristics *</b>					
$h_{FE}$	DC Current Gain	$V_{CE} = -2.0\text{V}, I_C = -10\text{mA}$ $V_{CE} = -2.0\text{V}, I_C = -500\text{mA}$ $V_{CE} = -2.0\text{V}, I_C = -1.0\text{A}$ $V_{CE} = -2.0\text{V}, I_C = -2.0\text{A}$	300 250 200 150	800	
$V_{CE(sat)}$	Collector-Emitter Saturation Voltage	$I_C = -500\text{mA}, I_B = -5.0\text{mA}$ $I_C = -1.0\text{A}, I_B = -10\text{mA}$ $I_C = -2.0\text{A}, I_B = -50\text{mA}$		-0.25 -0.45 -0.75	mV
$V_{BE(sat)}$	Base-Emitter Saturation Voltage	$I_C = -1.0\text{A}, I_B = -10\text{mA}$		-1.0	V
$V_{BE(on)}$	Base-Emitter On Voltage	$I_C = -1.0\text{A}, V_{CE} = -2.0\text{V}$		-1.0	V
<b>Small Signal Characteristics</b>					
$f_T$	Transition Frequency	$I_C = -50\text{mA}, V_{CE} = -5.0\text{V},$ $f = 50\text{MHz}$	100		MHz

\* Pulse Test: Pulse Width  $\leq 300\mu\text{s}$ , Duty Cycle  $\leq 2.0\%$

## Thermal Characteristics

Symbol	Parameter	Max.	Units
$P_D$	Total Device Dissipation	2	W
$R_{\theta JA}$	Thermal Resistance, Junction to Ambient	62.5	$^\circ\text{C/W}$

# Typical Characteristics

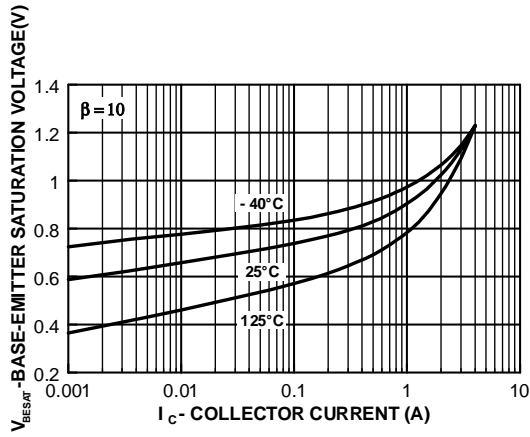

Figure 1. Base-Emitter Saturation Voltage vs Collector Current

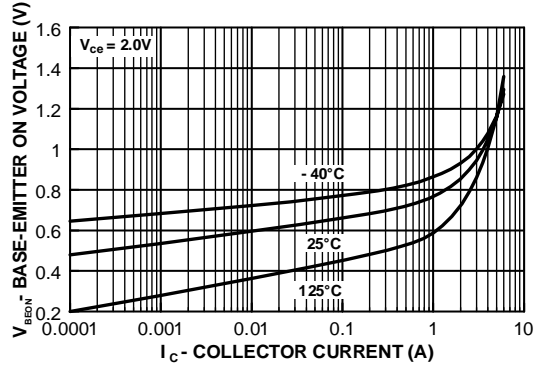

Figure 2. Base-Emitter On Voltage vs Collector Current

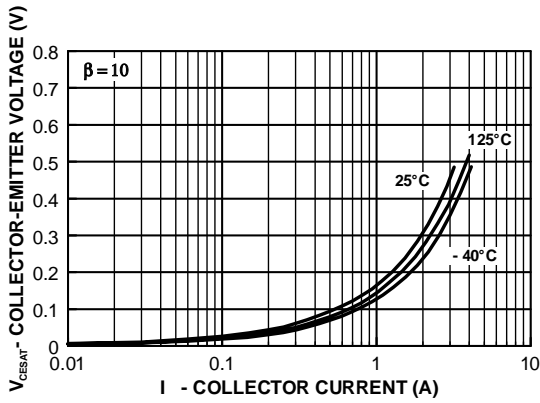

Figure 3. Collector-Emitter Saturation Voltage vs Collector Current

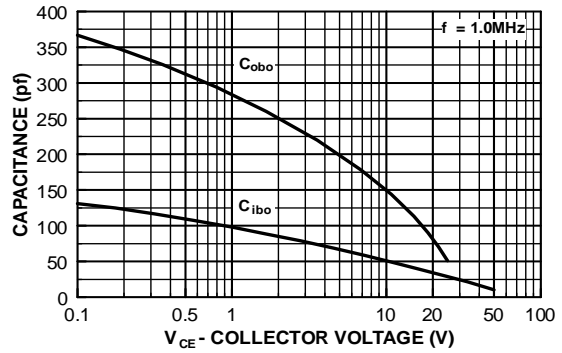

Figure 4. Input/Output Capacitance vs Reverse Bias Voltage

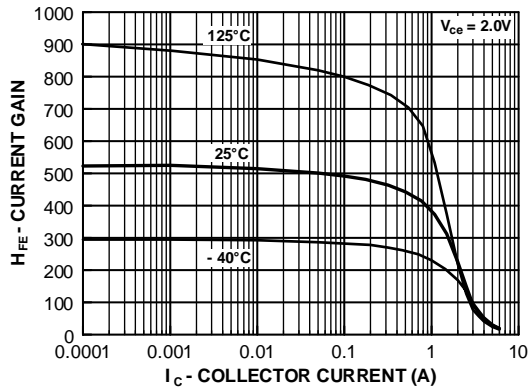

Figure 5. Current Gain vs Collector Current

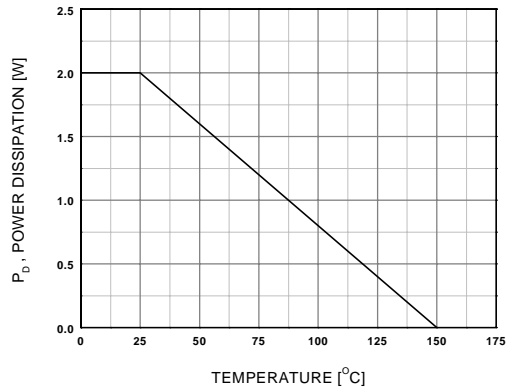
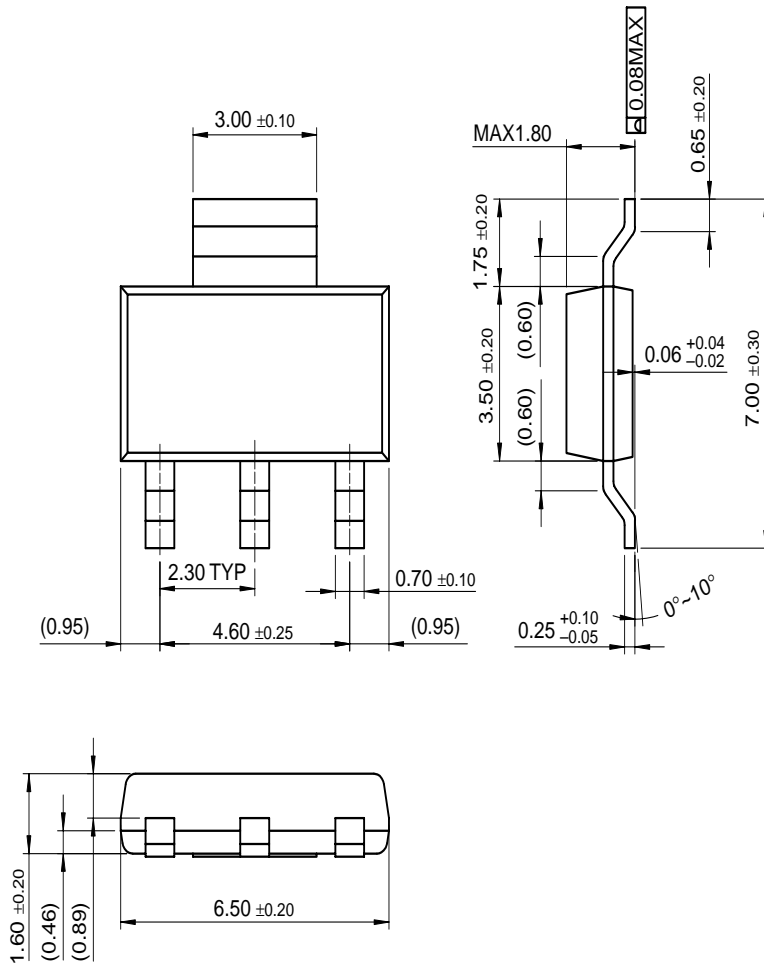

Figure 6. Power Dissipation vs Ambient Temperature

# Package Dimensions

FZT790A

## SOT-223



Dimensions in Millimeters

## TRADEMARKS

The following are registered and unregistered trademarks Fairchild Semiconductor owns or is authorized to use and is not intended to be an exhaustive list of all such trademarks.

ACE <sup>™</sup>	FACT <sup>™</sup>	ImpliedDisconnect <sup>™</sup>	PACMAN <sup>™</sup>	SPM <sup>™</sup>
ActiveArray <sup>™</sup>	FACT Quiet series <sup>™</sup>	ISOPLANAR <sup>™</sup>	POP <sup>™</sup>	Stealth <sup>™</sup>
Bottomless <sup>™</sup>	FAST <sup>®</sup>	LittleFET <sup>™</sup>	Power247 <sup>™</sup>	SuperSOT <sup>™</sup> -3
CoolFET <sup>™</sup>	FAST <sup>™</sup>	MicroFET <sup>™</sup>	PowerTrench <sup>®</sup>	SuperSOT <sup>™</sup> -6
CROSSVOLT <sup>™</sup>	FRFET <sup>™</sup>	MicroPak <sup>™</sup>	QFET <sup>™</sup>	SuperSOT <sup>™</sup> -8
DOMET <sup>™</sup>	GlobalOptoisolator <sup>™</sup>	MICROWIRE <sup>™</sup>	QS <sup>™</sup>	SyncFET <sup>™</sup>
EcoSPARK <sup>™</sup>	GTO <sup>™</sup>	MSX <sup>™</sup>	QT Optoelectronics <sup>™</sup>	TinyLogic <sup>™</sup>
E <sup>2</sup> CMOS <sup>™</sup>	HiSeC <sup>™</sup>	MSXPro <sup>™</sup>	Quiet Series <sup>™</sup>	TruTranslation <sup>™</sup>
EnSigna <sup>™</sup>	I <sup>2</sup> C <sup>™</sup>	OCX <sup>™</sup>	RapidConfigure <sup>™</sup>	UHC <sup>™</sup>
Across the board. Around the world. <sup>™</sup>		OCXPro <sup>™</sup>	RapidConnect <sup>™</sup>	UltraFET <sup>®</sup>
The Power Franchise <sup>™</sup>		OPTOLOGIC <sup>®</sup>	SILENT SWITCHER <sup>®</sup>	VCX <sup>™</sup>
Programmable Active Droop <sup>™</sup>		OPTOPLANAR <sup>™</sup>	SMART START <sup>™</sup>	

## DISCLAIMER

FAIRCHILD SEMICONDUCTOR RESERVES THE RIGHT TO MAKE CHANGES WITHOUT FURTHER NOTICE TO ANY PRODUCTS HEREIN TO IMPROVE RELIABILITY, FUNCTION OR DESIGN. FAIRCHILD DOES NOT ASSUME ANY LIABILITY ARISING OUT OF THE APPLICATION OR USE OF ANY PRODUCT OR CIRCUIT DESCRIBED HEREIN; NEITHER DOES IT CONVEY ANY LICENSE UNDER ITS PATENT RIGHTS, NOR THE RIGHTS OF OTHERS.

## LIFE SUPPORT POLICY

FAIRCHILD'S PRODUCTS ARE NOT AUTHORIZED FOR USE AS CRITICAL COMPONENTS IN LIFE SUPPORT DEVICES OR SYSTEMS WITHOUT THE EXPRESS WRITTEN APPROVAL OF FAIRCHILD SEMICONDUCTOR CORPORATION.

As used herein:

1. Life support devices or systems are devices or systems which, (a) are intended for surgical implant into the body, or (b) support or sustain life, or (c) whose failure to perform when properly used in accordance with instructions for use provided in the labeling, can be reasonably expected to result in significant injury to the user.
2. A critical component is any component of a life support device or system whose failure to perform can be reasonably expected to cause the failure of the life support device or system, or to affect its safety or effectiveness.

## PRODUCT STATUS DEFINITIONS

### Definition of Terms

Datasheet Identification	Product Status	Definition
Advance Information	Formative or In Design	This datasheet contains the design specifications for product development. Specifications may change in any manner without notice.
Preliminary	First Production	This datasheet contains preliminary data, and supplementary data will be published at a later date. Fairchild Semiconductor reserves the right to make changes at any time without notice in order to improve design.
No Identification Needed	Full Production	This datasheet contains final specifications. Fairchild Semiconductor reserves the right to make changes at any time without notice in order to improve design.
Obsolete	Not In Production	This datasheet contains specifications on a product that has been discontinued by Fairchild semiconductor. The datasheet is printed for reference information only.