

# FPF2500-FPF2506 IntelliMAX™ Advanced Load Management Products

## Features

- 4.5 to 20V Input Voltage Range
- Controlled Turn-On
- 0.4A, 0.8A and Adjustable Current Limit Option
- Undervoltage Lockout
- Thermal Shutdown
- <10µA Shutdown Current
- Auto Restart
- Fault Blanking
- RoHS Compliant

## Applications

- PDAs
- Motor Drivers
- Cell Phones
- Digital Cameras



## General Description

The FPF2500 through FPF2506 is a family of load switches which provide full protection to systems and loads which may encounter large current conditions. These devices contain a 0.23Ω current-limited N-channel MOSFET which can operate over an input voltage range of 4.5-20V. Switch control is by a logic input (ON) capable of interfacing directly with low voltage control signals. Each part contains thermal shutdown protection which shuts off the switch to prevent damage to the part when a continuous over-current condition causes excessive heating.

When the switch current reaches the current limit, the part operates in a constant-current mode to prohibit excessive currents from causing damage. For the FPF2500, FPF2501, FPF2503 and FPF2505, if the constant current condition still persists after 5ms, these parts will shut off the switch and, for the FPF2503 and FPF2505, the fault signal pin (FLAGB) will be pulled low. The FPF2500, FPF2503, and FPF2505, have an auto-restart feature which will turn the switch on again after 640ms if the ON pin is still active. The FPF2501 does not have this auto-restart feature so the switch will remain off until the ON pin is cycled. For the FPF2502, FPF2504 and FPF2506, a current limit condition will immediately pull the fault signal pin low and the part will remain in the constant-current mode until the switch current falls below the current limit. For the FPF2500 through FPF2502, the minimum current limit is adjustable from 500mA to 2A. For the FPF2503 and FPF2504 the minimum current is internally fixed at 400mA while that for the FPF2505 and FPF2506 is internally fixed at 800mA.

These parts are available in a space-saving 5 pin SOT23 package.

## Ordering Information

Part	Current Limit [A]	Current Limit Blanking Time [ms]	Auto-Restart Time [ms]	Fault Pin
FPF2500	Adjustable (0.5-2.0 +/-30%)	2.5/5/10	320/640/1280	No
FPF2501	Adjustable (0.5-2.0 +/-30%)	2.5/5/10	NA	No
FPF2502	Adjustable (0.5-2.0 +/-30%)	0	NA	No
FPF2503	0.4/0.6/0.8	2.5/5/10	320/640/1280	Yes
FPF2504	0.4/0.6/0.8	0	NA	Yes
FPF2505	0.8/1.2/1.6	2.5/5/10	320/640/1280	Yes
FPF2506	0.8/1.2/1.6	0	NA	Yes

### Typical Application Circuit

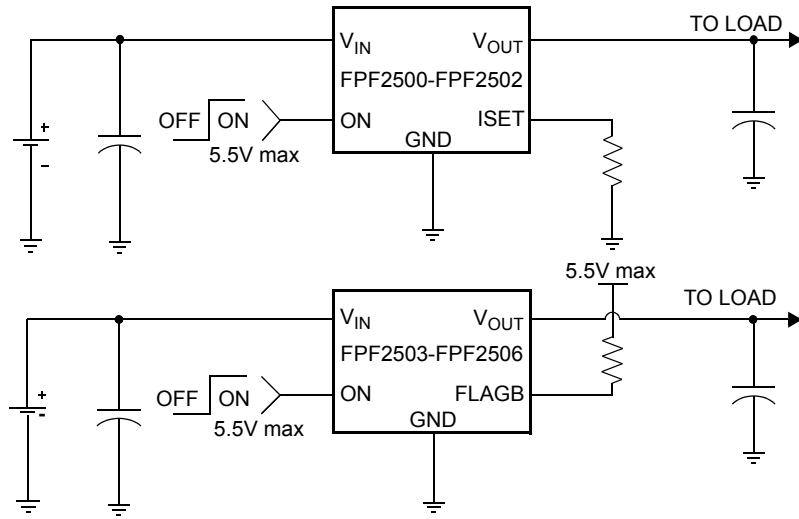

### Functional Block Diagram

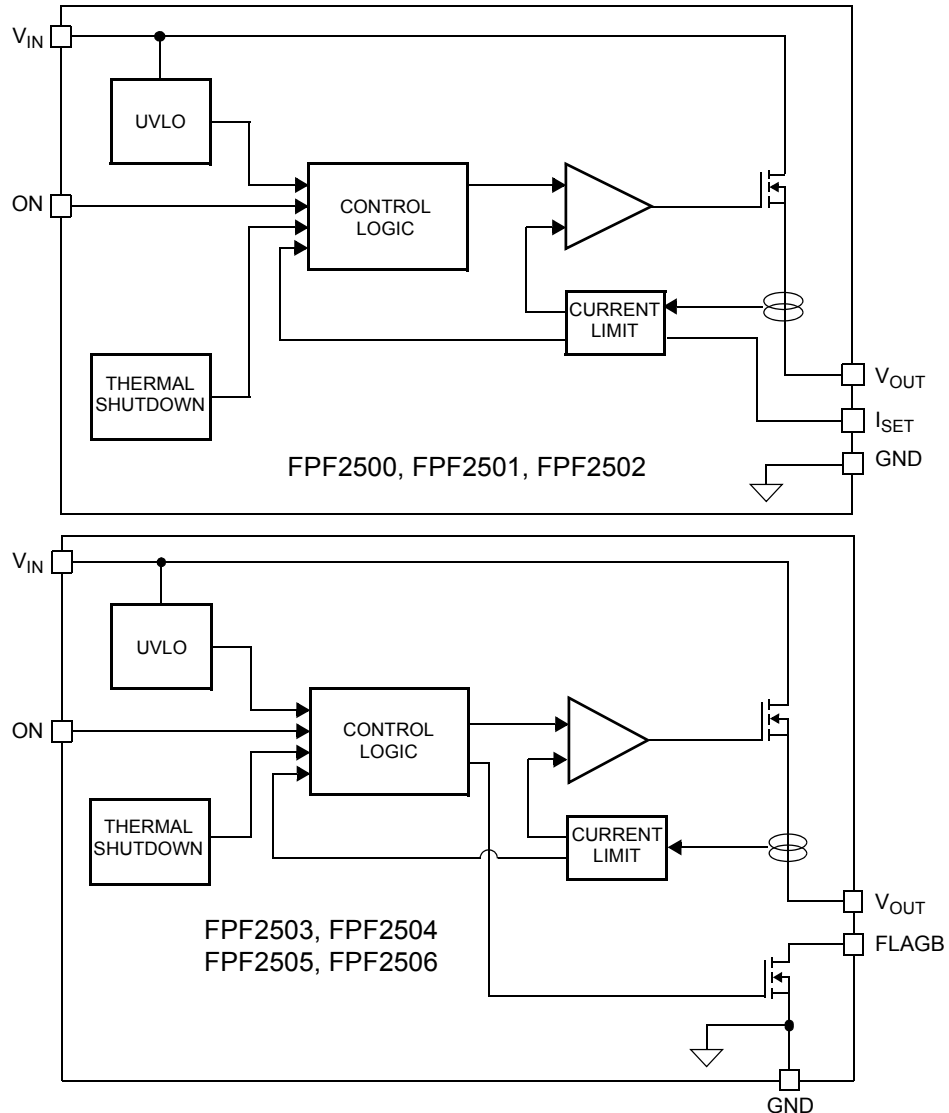

## Pin Configuration

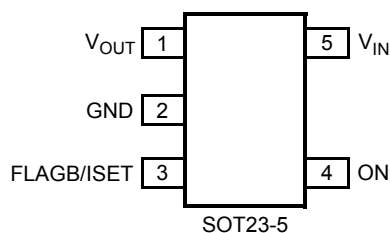

## Pin Description

Pin	Name	Function
1	V <sub>OUT</sub>	Switch Output: Output of the power switch
2	GND	Ground
3	FLAGB	Fault Output (FPF2503-FPF2506): Active LO, open drain output which indicates on over current supply under voltage or over temperature state.
	ISET	Adjustable Current Limit Setting Resistor (FPF2500-FPF2502): An external resistor connected between this pin and ground sets the current limit value.
4	ON	ON Control Input:
5	V <sub>IN</sub>	Supply Input: Input to the power switch and the supply voltage for the IC

## Absolute Maximum Ratings

Parameter	Min	Max	Unit
V <sub>IN</sub> , V <sub>OUT</sub> , to GND	-0.3	20	V
ON, FLAGB, ISET to GND	-0.3	5.5	V
Power Dissipation @ T <sub>A</sub> =25°C (Note 1)		667	mW
Operating Temperature Range	-40	125	°C
Storage Temperature	-65	150	°C
Thermal Resistance, Junction to Ambient		150	°C/W
Electrostatic Discharge Protection	HBM	2000	V
	MM	200	V

## Recommended Operating Range

Parameter	Min	Max	Unit
V <sub>IN</sub>	4.5	20	V
Ambient Operating Temperature, T <sub>A</sub>	-40	85	°C

## Electrical Characteristics

V<sub>IN</sub> = 4.5 to 20V, T<sub>A</sub> = -40 to +85°C unless otherwise noted. Typical values are at V<sub>IN</sub> = 12V and T<sub>A</sub> = 25°C.

Parameter	Symbol	Conditions	Min	Typ	Max	Unit
<b>Basic Operation</b>						
Operating Voltage	V <sub>IN</sub>		4.5		20	V
Quiescent Current	I <sub>Q</sub>	I <sub>OUT</sub> = 0mA, V <sub>IN</sub> = 12V, V <sub>ON</sub> =5V		60	100	μA
Shutdown Current	I <sub>SHDN</sub>				1	μA
Latch-Off Current	I <sub>LATCHOFF</sub>	FPF2501		45		μA
On-Resistance	R <sub>ON</sub>	V <sub>IN</sub> = 12V, I <sub>OUT</sub> = 50mA, T <sub>A</sub> = 25°C		230	320	mΩ
		V <sub>IN</sub> = 12V, I <sub>OUT</sub> = 50mA, T <sub>A</sub> = 85°C		300	400	
		V <sub>IN</sub> = 12V, I <sub>OUT</sub> = 50mA, T <sub>A</sub> = -40°C to +85°C	110		400	

## Electrical Characteristics Cont.

$V_{IN} = 4.5$  to  $20V$ ,  $T_A = -40$  to  $+85^\circ C$  unless otherwise noted. Typical values are at  $V_{IN} = 12V$  and  $T_A = 25^\circ C$ .

Parameter	Symbol	Conditions	Min	Typ	Max	Unit	
ON Input Logic High Voltage	$V_{IH}$	$V_{IN} = 4.5V$ to $20V$	0.9			V	
ON Input Logic Low Voltage	$V_{IL}$	$V_{IN} = 4.5V$ to $20V$			0.4	V	
ON Input Leakage		$V_{ON} = 5V$ or GND	-1		1	$\mu A$	
Off Switch Leakage	$I_{SWOFF}$	$V_{ON} = 0V$ , $V_{OUT} = 0V$ @ $V_{IN} = 12V$			1	$\mu A$	
		$V_{ON} = 0V$ , $V_{OUT} = 0V$ @ $V_{IN} = 12V$ , $T_A = 25^\circ C$		30	100	nA	
FLAGB Output Logic Low Voltage		$V_{IN} = 5V$ , $I_{SINK} = 10mA$		0.1	0.2	V	
FLAGB Output High Leakage Current		$V_{IN} = 5V$ , Switch on			1	$\mu A$	
<b>Protections</b>							
Current Limit	$I_{LIM}$	$T_A = 25^\circ C$	FPF2503, FPF2504	400	600	800	mA
			FPF2505, FPF2506	800	1200	1600	
			FPF2500, FPF2501 FPF2502	$0.7 \times I_{NOM}$	$1.0 \times I_{NOM}$	$1.3 \times I_{NOM}$	
Thermal Shutdown		$T_J$ Increasing		140		$^\circ C$	
		$T_J$ Decreasing		130		$^\circ C$	
Under Voltage Shutdown	UVLO	$V_{IN}$ Increasing	3.75	3.85	4.00	V	
Under Voltage Shutdown Hysteresis				100		mV	
<b>Dynamic</b>							
Turn On Time	$t_{ON}$	$R_L = 500\Omega$ , $C_L = 0.1\mu F$		1		ms	
Turn Off Time	$t_{OFF}$	$R_L = 500\Omega$ , $C_L = 0.1\mu F$		0.1		ms	
$V_{OUT}$ Rise Time	$t_R$	$R_L = 500\Omega$ , $C_L = 0.1\mu F$		3		ms	
$V_{OUT}$ Fall Time	$t_F$	$R_L = 500\Omega$ , $C_L = 0.1\mu F$		1.5		ms	
Over Current Blanking Time	$t_{BLANK}$	FPF2500, FPF2501, FPF2503, FPF2505	2.5	5	10	ms	
Auto-Restart Time	$t_{RESTART}$	FPF2500, FPF2503, FPF2505	320	640	1280	ms	
Short Circuit Response Time		$V_{IN} = 12V$ , $V_{ON} = 5V$ Moderate Overcurrent Condition		3		$\mu s$	

**Note 1:** Package power dissipation on 1 square inch pad, 2 oz. copper board.

## Typical Characteristics

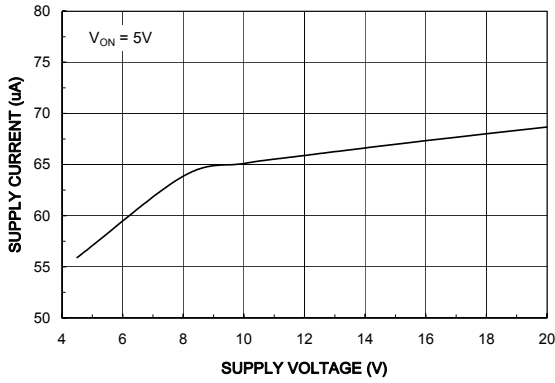

Figure 1. Quiescent Current vs. Input Voltage

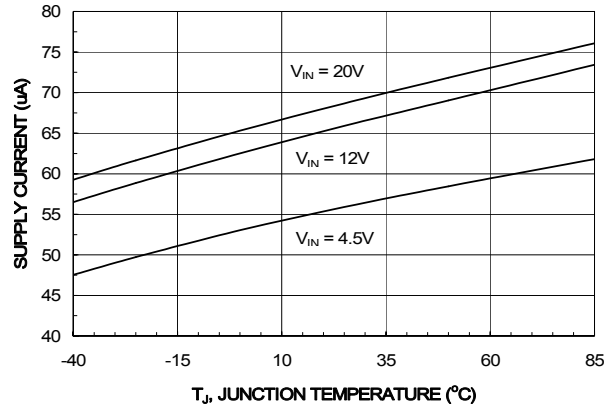

Figure 2. Quiescent Current vs. Temperature

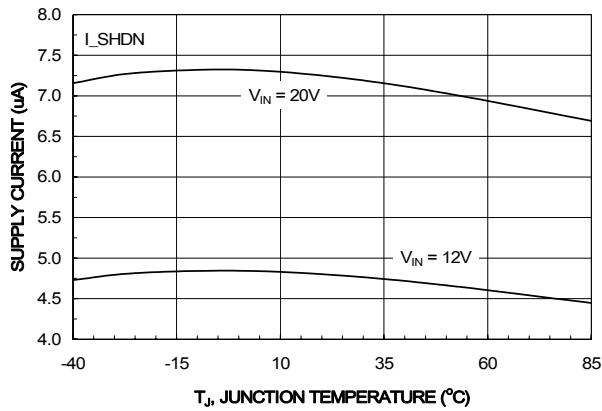

Figure 3. I<sub>SHUTDOWN</sub> Current vs. Temperature

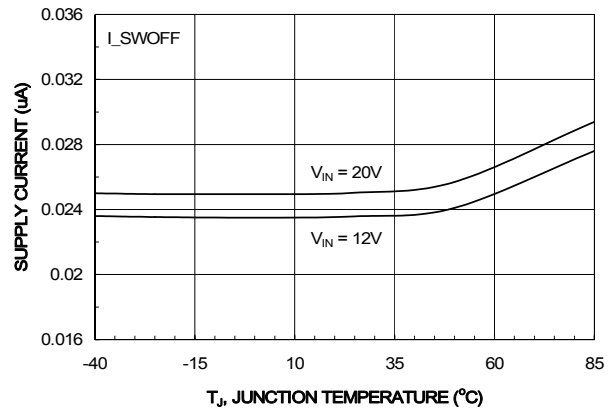

Figure 4. I<sub>SWITCH-OFF</sub> Current vs. Temperature

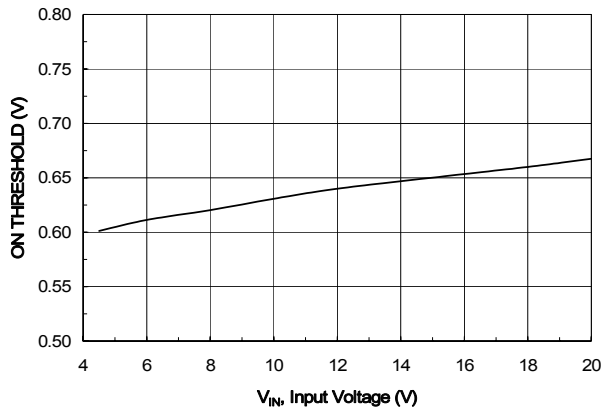

Figure 5. V<sub>IH</sub> vs. V<sub>IN</sub>

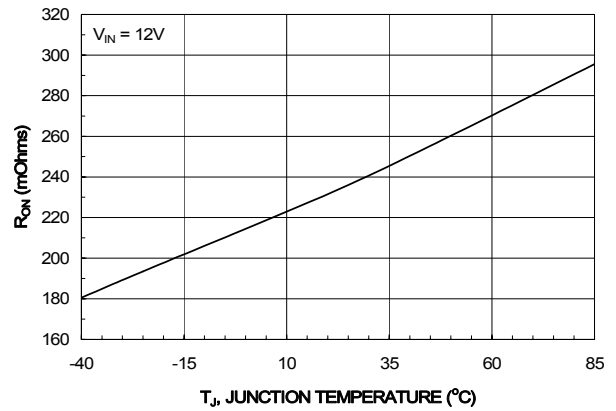

Figure 6. R<sub>ON</sub> vs. Temperature

## Typical Characteristics

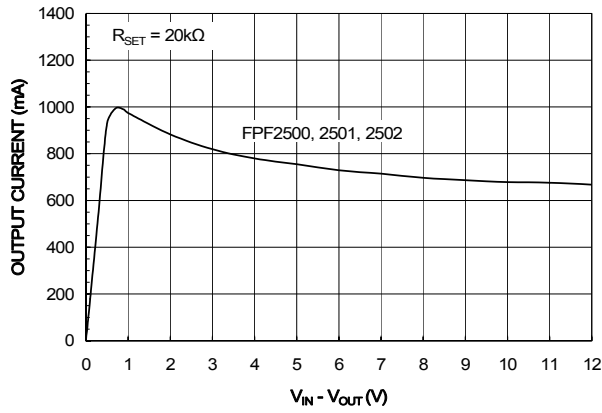

Figure 7. Current Limit vs. Output Voltage

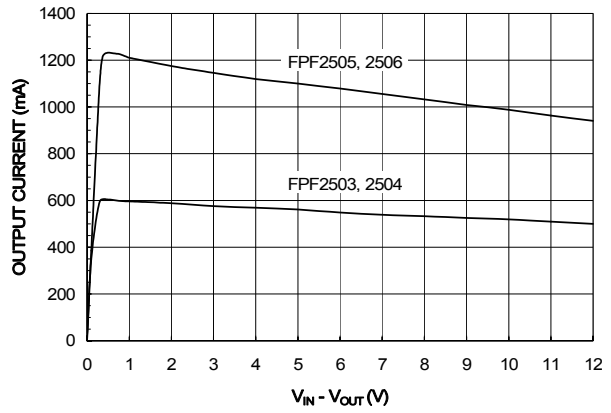

Figure 8. Current Limit vs. Output Voltage

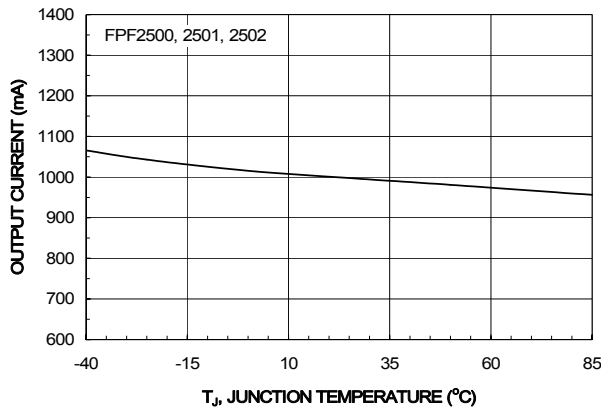

Figure 9. Current Limit vs. Temperature

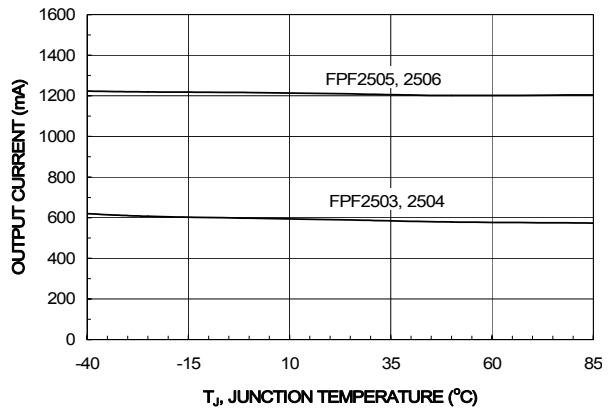

Figure 10. Current Limit vs. Temperature

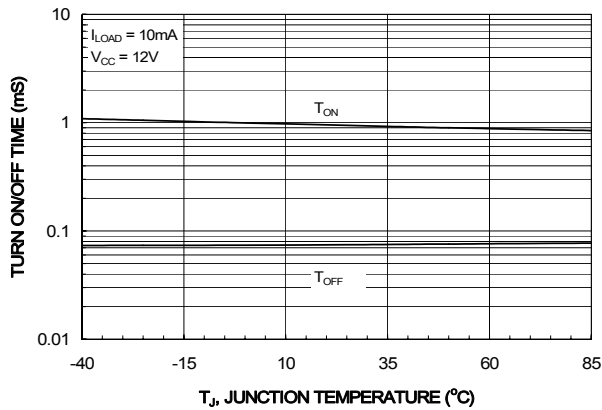

Figure 11.  $T_{ON}/T_{OFF}$  vs. Temperature

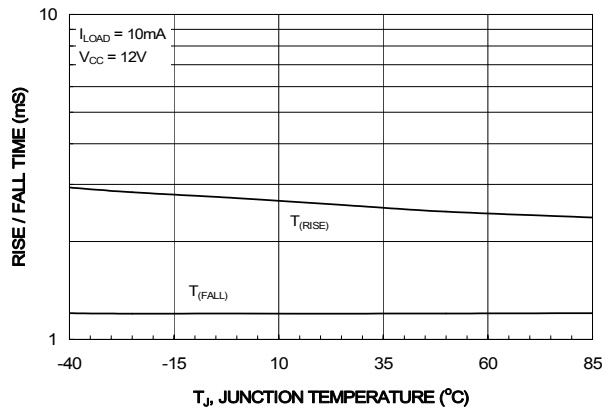

Figure 12.  $T_{RISE}/T_{FALL}$  vs. Temperature

## Typical Characteristics

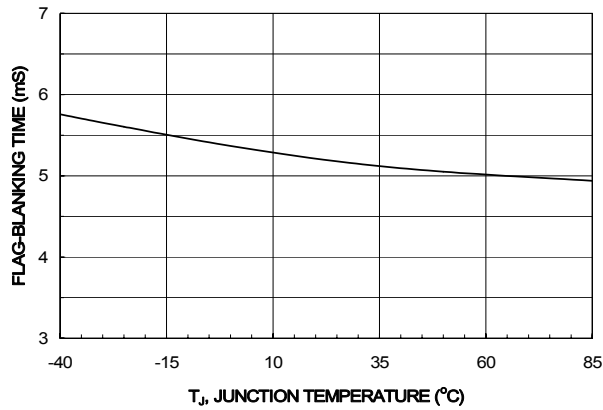

Figure 13. T<sub>BLANK</sub> vs. Temperature

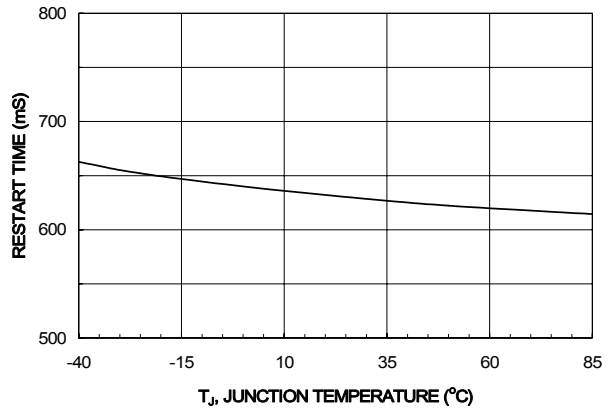

Figure 14. T<sub>RESTART</sub> vs. Temperature

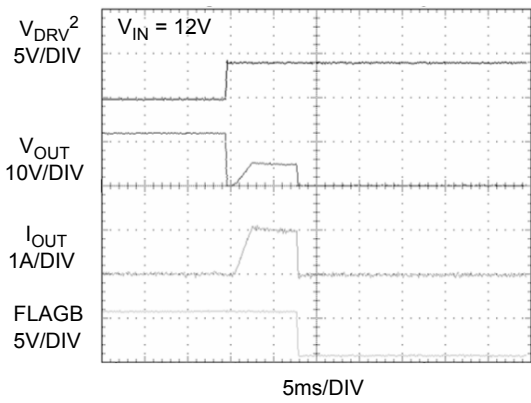

Figure 15. T<sub>BLANK</sub> Response  
(Switch is turned on to an overcurrent condition)

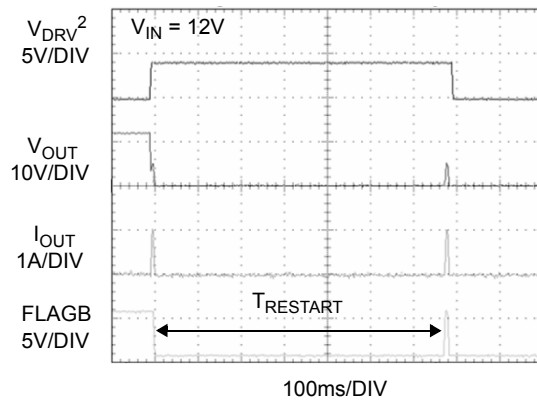

Figure 16. T<sub>RESTART</sub> Response (FPF2505)

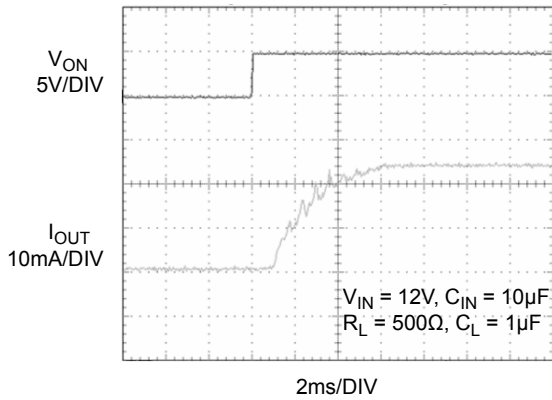

Figure 17. T<sub>ON</sub> Response

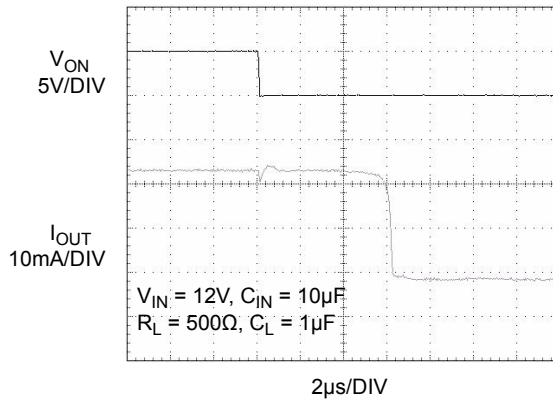

Figure 18. T<sub>OFF</sub> Response

### Typical Characteristics

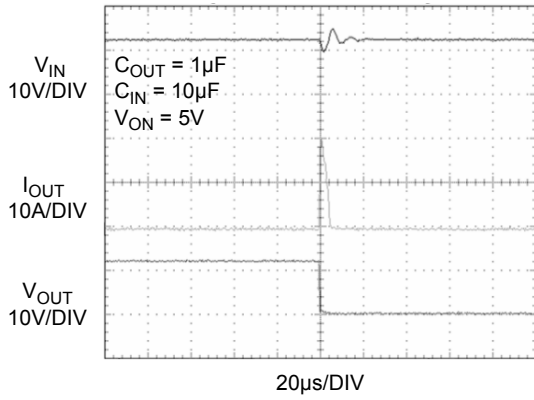

Figure 19. Short Circuit Response  
(Output is shorted to GND)

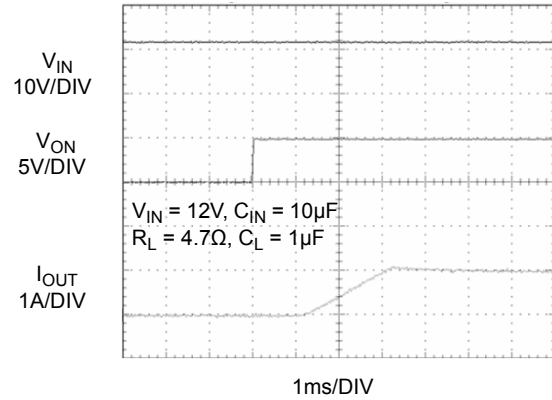

Figure 20. Current Limit Response

**Note 2:**  $V_{DRV}$  signal forces the device to go into overcurrent condition.



## Description of Operation

The FPF2500 - FPF2506 are current limited switches that protect systems and loads which can be damaged or disrupted by the application of high currents. The core of each device is a 0.23Ω N-channel MOSFET and a controller capable of functioning over a wide input operating range of 4.5 V -20 V. The controller protects against system malfunctions through current limiting under-voltage lockout and thermal shutdown. The current limit for FPF2500, FPF2501 and FPF2502 is adjustable from 500mA to 2A through the selection of an external resistor. The FPF2503 and FPF2504 the minimum current is internally fixed at 400 mA while that for the FPF2505 and FPF2506 is internally fixed at 800mA.

## On/Off Control

The ON pin controls the state of the switch. When ON is high, the switch is in the on state. Activating ON continuously holds the switch in the on state so long as there is no fault. For all versions, an under-voltage on  $V_{IN}$  or a junction temperature in excess of 140°C overrides the ON control to turn off the switch. In addition, excessive currents will cause the switch to turn off in the FPF2500, FPF2501, FPF2503 and FPF2505. The FPF2500, FPF2503 and FPF2505 have an Auto-Restart feature which will automatically turn the switch on again after 640ms. For the FPF2501, the ON pin must be toggled to turn-on the switch again. The FPF2502, FPF2504 and FPF2506 does not turn off in response to an over current condition but instead remains operating in a constant current mode so long as ON is active and the thermal shutdown or under-voltage lockout have not activated.

## Current Limiting

The current limit ensures that the current through the switch doesn't exceed a maximum value while not limiting at less than a minimum value. For the FPF2500, FPF2501 and FPF2502, the current at which the parts will limit is adjustable through the selection of an external resistor connected to  $I_{SET}$ . Information for selecting the resistor is found in the Application Info section. For the FPF2503 and FPF2504 the minimum current is 400mA and the maximum current is 800mA and for the FPF2505-FPF2506 the minimum current is 800mA and the maximum current is 1600mA. The FPF2500, FPF2501, FPF2503 and FPF2505 have a blanking time of 5ms, nominally, during which the switch will act as a constant current source. At the end of the blanking time, the switch will be turned-off. For FPF2503 and FPF2505, at the end of the blanking time, the switch will be turned-off and the FLAGB pin will activate to indicate that current limiting has occurred. The FPF2502, FPF2504 and FPF2506 have no current limit blanking period so they will remain in a constant current state. For FPF2504 and FPF2506, immediately upon a current limit condition FLAGB is activated. The FPF2502, FPF2504 and FPF2506 devices will remain in constant current state until the ON pin is cycled or the thermal shutdown turns-off the switch.

## Under-Voltage Lockout

The under-voltage lockout turns-off the switch if the input voltage drops below the under-voltage lockout threshold. With the ON pin active, the input voltage rising above the under-voltage lockout threshold will cause a controlled turn-on of the switch which limits current over-shoots.

## Thermal Shutdown

The thermal shutdown protects the die from internally or externally generated excessive temperatures. During an over-temperature condition the switch is turned-off. The switch automatically turns-on again if the temperature of the die drops below the threshold temperature.

## Application Information

### Typical Application

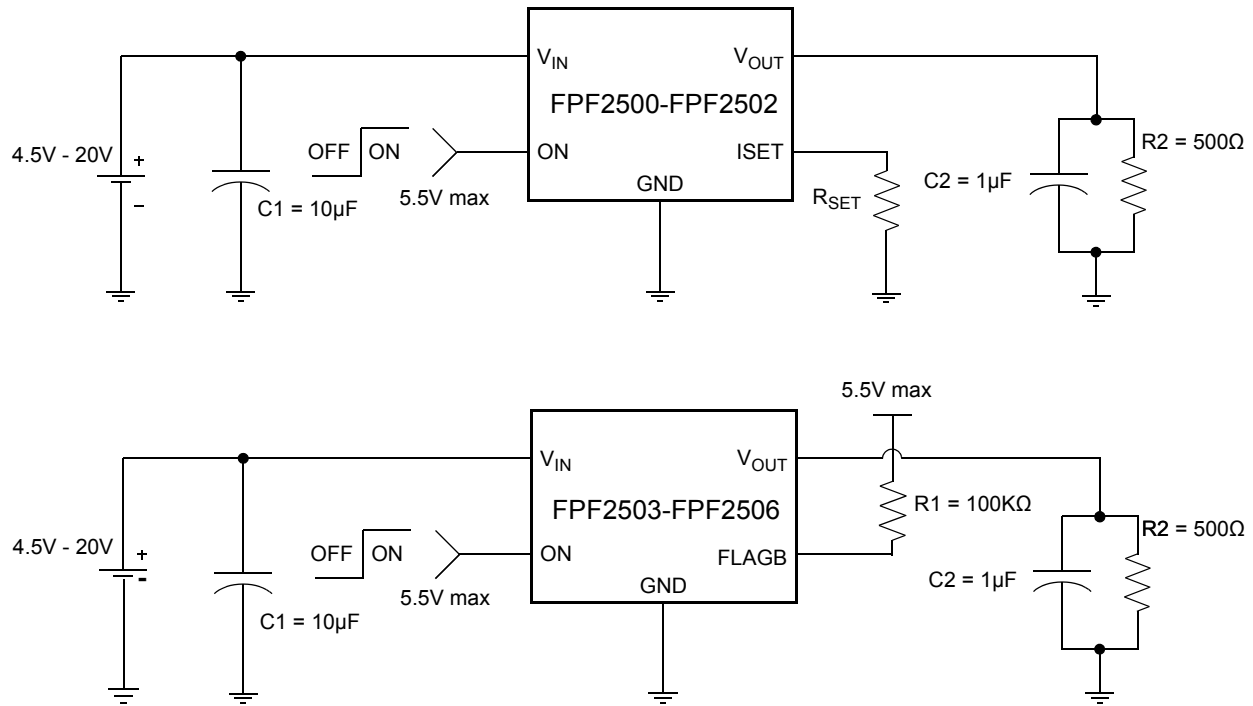

### Setting Current Limit

The FPF2500, FPF2501, and FPF2502 have a current limit which is set with an external resistor connected between I<sub>SET</sub> and GND. This resistor is selected by using the following equation,

$$R_{SET} = 12500 \times I_{SET} \times e^{(0.485 \times I_{SET})} \quad (1)$$

R<sub>SET</sub> is in Ohms and I<sub>SET</sub> is in Amps

The following table can also be used to select R<sub>SET</sub>. A typical application would be the 0.500A current that is required by a single USB port. Using the table below an appropriate selection for the R<sub>SET</sub> resistor would be 12.4KΩ. This will ensure that the port load could draw 0.525A, but not more than 0.875A. Likewise for a dual port system, an R<sub>SET</sub> of 34.8KΩ would always deliver at least 1.050A and never more than 1.750A.

### Input Capacitor

To limit the voltage drop on the input supply caused by transient in-rush currents when the switch turns-on into a discharged load capacitor or a short-circuit, a capacitor needs to be placed between V<sub>IN</sub> and GND. A 0.1µF ceramic capacitor, C<sub>IN</sub>, must be placed close to the V<sub>IN</sub> pin. A higher value of C<sub>IN</sub> can be used to further reduce the voltage drop experienced as the switch is turned on into a large capacitive load.

### Current Limit Various R<sub>SET</sub> Values

R <sub>SET</sub> [KΩ]	Min. Current Limit [A]	Typ. Current Limit [A]	Max. Current Limit [A]
7.87	0.375	0.500	0.625
10.0	0.450	0.600	0.750
12.4	0.525	0.700	0.875
14.7	0.600	0.800	1.000
17.4	0.675	0.900	1.125
20.5	0.750	1.000	1.250
23.2	0.825	1.100	1.375
26.7	0.900	1.200	1.500
30.9	0.975	1.300	1.625
34.8	1.050	1.400	1.750
39.0	1.125	1.500	1.875
43.2	1.200	1.600	2.000
48.7	1.275	1.700	2.125
53.6	1.350	1.800	2.250
59.6	1.425	1.900	2.375
64.9	1.500	2.000	2.500

## Output Capacitor

A 0.1µF capacitor  $C_{OUT}$ , should be placed between  $V_{OUT}$  and GND. This capacitor will prevent parasitic board inductances from forcing  $V_{OUT}$  below GND when the switch turns-off. For the FPF2501, FPF2503 and FPF2505, the total output capacitance needs to be kept below a maximum value,  $C_{OUT(max)}$ , to prevent the part from registering an over-current condition and turning off the switch. The maximum output capacitance can be determined from the following formula,

$$C_{OUT(max)} = \frac{I_{LIM(min)} \times t_{BLANK(min)}}{V_{IN}} \quad (2)$$

## Power Dissipation

Due to the wide input voltage range that the parts can accept and the high currents at which the current limit can be set, care must be taken to prevent excessive power dissipation in the part from interrupting the switching of power to a load. During normal operation as a switch, the power dissipated in the part will depend upon the level at which the current limit is set. For a 0.5A typical load, the power dissipated will typically be,

$$P = (I_{LIM})^2 \times R_{DS} = (0.5)^2 \times 0.23 = 58mW \quad (3)$$

This is well within the thermal capability of the package. The maximum allowed setting for the current limit is 2A and this will result in a power dissipation of typically,

$$P = (I_{LIM})^2 \times R_{DS} = (2)^2 \times 0.23 = 920mW \quad (4)$$

This is beyond the normal thermal capability of the package, but the thermal shutdown within the part will prevent damage by turning off the switch once the maximum junction temperature has been reached. If the part goes into current limit the maximum power dissipation will occur when the output is shorted to ground. For the FPF2500, FPF2503 and FPF2505 the power dissipation will scale by the Auto-Restart Time,  $t_{RESTART}$ , and the Over Current Blanking Time,  $t_{BLANK}$ , so that the maximum power dissipated is,

$$\begin{aligned} P(max) &= \frac{t_{BLANK}}{t_{RESTART} + t_{BLANK}} \times V_{IN(max)} \times I_{LIM(max)} \\ &= \frac{5}{5 + 640} \times 20 \times 2.5 = 388mW \end{aligned} \quad (5)$$

This is more power than the package can dissipate, but the thermal shutdown of the part will activate to protect the part from damage due to excessive heating. The junction temperature will only be able to increase to the thermal shutdown threshold. Once this temperature has been reached, toggling ON will not turn-on the switch until the junction temperature drops. For the FPF2502, FPF2504 and FPF2506, a short on the output will cause the part to operate in a constant current state dissipating a worst case power of,

$$\begin{aligned} P(max) &= V_{IN(max)} \times I_{LIM(max)} \\ &= 20 \times 2.5 = 50W \end{aligned} \quad (6)$$

This large amount of power will activate the thermal shutdown and the part will cycle in and out of thermal shutdown so long as the ON pin is active and the short is present.

## Board Layout

For best performance, all traces should be as short as possible. To be most effective, the input and output capacitors should be placed close to the device to minimize the effects that parasitic trace inductances may have on normal and short-circuit operation. Using wide traces for  $V_{IN}$ ,  $V_{OUT}$  and GND will help minimize parasitic electrical effects along with minimizing the case to ambient thermal impedance.

# Dimensional Outline and Pad Layout

## Package MA05B

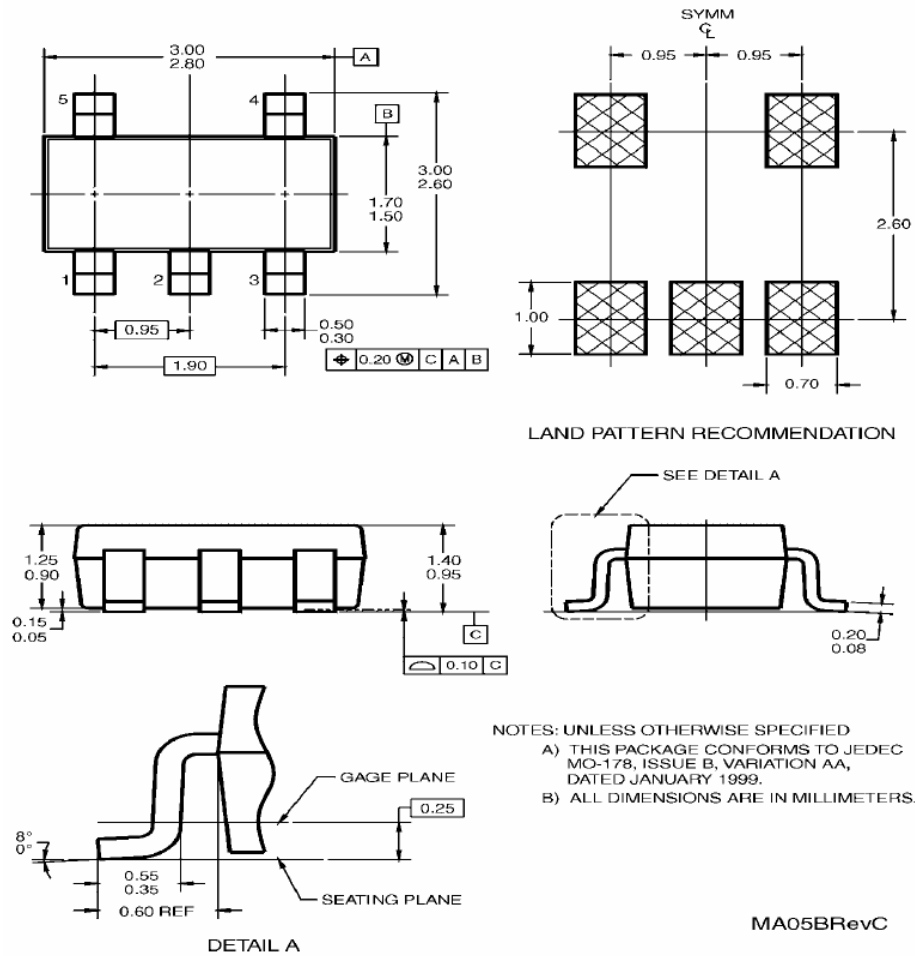

NOTES: UNLESS OTHERWISE SPECIFIED  
 A) THIS PACKAGE CONFORMS TO JEDEC MO-178, ISSUE B, VARIATION AA, DATED JANUARY 1999.  
 B) ALL DIMENSIONS ARE IN MILLIMETERS.





MA05BRevC

5-Lead SOT23, JEDEC MO-178, 1.6mm  
 Package Number MA05B



**TRADEMARKS**

The following are registered and unregistered trademarks and service marks Fairchild Semiconductor owns or is authorized to use and is not intended to be an exhaustive list of all such trademarks.

- |   |                                     |                            |  |
|---|-------------------------------------|----------------------------|--|
| ACEx®   | FPS™                                | PDP-SPM™                   | SupreMOS™  |
| Build it Now™   | FRFET®                              | Power220®                  | SyncFET™   |
| CorePLUS™   | Global Power Resource <sup>SM</sup> | POWEREDGE®                 |  SYSTEM®            |
| CROSSVOLT™  | Green FPS™                          | Power-SPM™                 | The Power Franchise®   |
| CTL™  | Green FPS™ e-Series™                | PowerTrench®               | the  <b>power</b> ™ |
| Current Transfer Logic™   | GTO™                                | Programmable Active Droop™ | franchise  |
| EcoSPARK®   | <i>i-Lo</i> ™                       | QFET®                      | TinyBoost™   |
| EZSWITCH™ *   | IntelliMAX™                         | QS™                        | TinyBuck™  |
|  ™ | ISOPLANAR™                          | QT Optoelectronics™        | TinyLogic®   |
|  ™ | MegaBuck™                           | Quiet Series™              | TINYOPTO™  |
| Fairchild®  | MICROCOUPLER™                       | RapidConfigure™            | TinyPower™   |
| Fairchild Semiconductor®  | MicroFET™                           | SMART START™               | TinyPWM™   |
| FACT Quiet Series™  | MicroPak™                           | SPM®                       | TinyWire™  |
| FACT®   | MillerDrive™                        | STEALTH™                   | µSerDes™   |
| FAST®   | Motion-SPM™                         | SuperFET™                  | UHC®   |
| FastvCore™  | OPTOLOGIC®                          | SuperSOT™-3                | Ultra FRFET™   |
| FlashWriter® *  | OPTOPLANAR®                         | SuperSOT™-6                | UniFET™  |
|   |                                     | SuperSOT™-8                | VCX™   |

\* EZSWITCH™ and FlashWriter® are trademarks of System General Corporation, used under license by Fairchild Semiconductor.

**DISCLAIMER**

FAIRCHILD SEMICONDUCTOR RESERVES THE RIGHT TO MAKE CHANGES WITHOUT NOTICE TO ANY PRODUCTS HEREIN TO IMPROVE RELIABILITY, FUNCTION, OR DESIGN. FAIRCHILD DOES NOT ASSUME ANY LIABILITY ARISING OUT OF THE APPLICATION OR USE OF ANY PRODUCT OR CIRCUIT DESCRIBED HEREIN; NEITHER DOES IT CONVEY ANY LICENSE UNDER ITS PATENT RIGHTS, NOR THE RIGHTS OF OTHERS. THESE SPECIFICATIONS DO NOT EXPAND THE TERMS OF FAIRCHILD'S WORLDWIDE TERMS AND CONDITIONS, SPECIFICALLY THE WARRANTY THEREIN, WHICH COVERS THESE PRODUCTS.

**LIFE SUPPORT POLICY**

FAIRCHILD'S PRODUCTS ARE NOT AUTHORIZED FOR USE AS CRITICAL COMPONENTS IN LIFE SUPPORT DEVICES OR SYSTEMS WITHOUT THE EXPRESS WRITTEN APPROVAL OF FAIRCHILD SEMICONDUCTOR CORPORATION.

As used herein:

- Life support devices or systems are devices or systems which, (a) are intended for surgical implant into the body, or (b) support or sustain life, and (c) whose failure to perform when properly used in accordance with instructions for use provided in the labeling, can be reasonably expected to result in significant injury to the user.
- A critical component is any component of a life support device or system whose failure to perform can be reasonably expected to cause the failure of the life support device or system, or to affect its safety or effectiveness.

**PRODUCT STATUS DEFINITIONS**

**Definition of Terms**

Datasheet Identification	Product Status	Definition
Advance Information	Formative or In Design	This datasheet contains the design specifications for product development. Specifications may change in any manner without notice.
Preliminary	First Production	This datasheet contains preliminary data; supplementary data will be published at a later date. Fairchild Semiconductor reserves the right to make changes at any time without notice to improve design.
No Identification Needed	Full Production	This datasheet contains final specifications. Fairchild Semiconductor reserves the right to make changes at any time without notice to improve design.
Obsolete	Not In Production	This datasheet contains specifications on a product that has been discontinued by Fairchild semiconductor. The datasheet is printed for reference information only.