

# FPF2172 IntelliMAX™ Advanced Load Management Products

## Features

- 1.8 to 5.5V Input Voltage Range
- Controlled Turn-On
- 200mA Current Limit Option
- Undervoltage Lockout
- Thermal Shutdown
- <1µA Shutdown Current
- Fast Current limit Response Time
  - 3µs to Moderate Over Currents
  - 20ns to Hard Shorts
- Integrated very low  $V_F$  Schottky Diode for Reverse Current Blocking
- RoHS Compliant

## Applications

- PDAs
- Cell Phones
- GPS Devices
- MP3 Players
- Digital Cameras
- Peripheral Ports
- Hot Swap Supplies



## General Description

The FPF2172 is a load switch which combines the functionality of the IntelliMAX™ series load switch with a very low forward voltage drop Schottky barrier rectifier. The integrated solution provides full protection to systems and loads which may encounter large current conditions in a very compact MLP 3x3 package. This device contains a 0.125Ω current-limited P-channel MOSFET which can operate over an input voltage range of 1.8-5.5V. The Schottky diode acts as a barrier so that no reverse current can flow when the MOSFET is off and the output voltage is higher than the input voltage. Switch control is by a logic input (ON) capable of interfacing directly with low voltage control signals. Each part contains thermal shutdown protection which shuts off the switch to prevent damage to the part when a continuous over-current condition causes excessive heating.

When the switch current reaches the current limit, the part operates in a constant-current mode to prohibit excessive currents from causing damage. If the constant current condition still persists after 10ms, these parts will shut off the switch and pull the fault signal pin (FLAGB) low. The switch will remain off until the ON pin is cycled. The minimum current limit is 200mA.

These parts are available in a space-saving 6L MLP 3x3 package.

## Typical Application Circuit

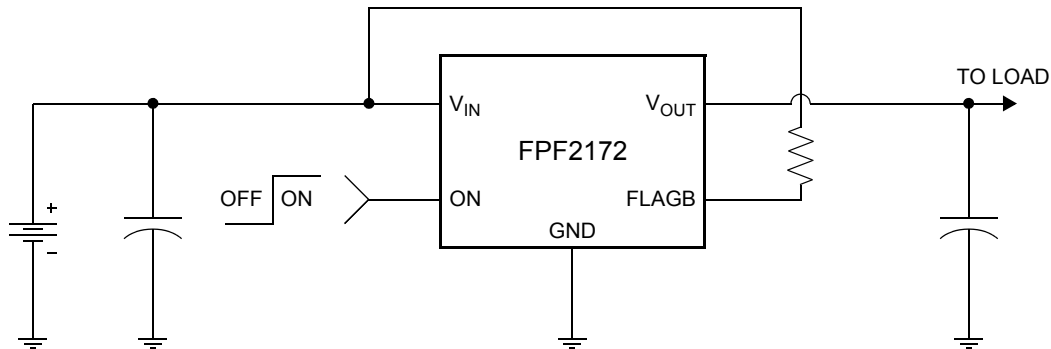

## Ordering Information

Part	Current Limit [mA]	Current Limit Blanking Time [ms]	Auto-Restart Time [ms]	ON Pin Activity	Top Mark
FPF2172	200	10	NA	Active HI	2172

### Functional Block Diagram

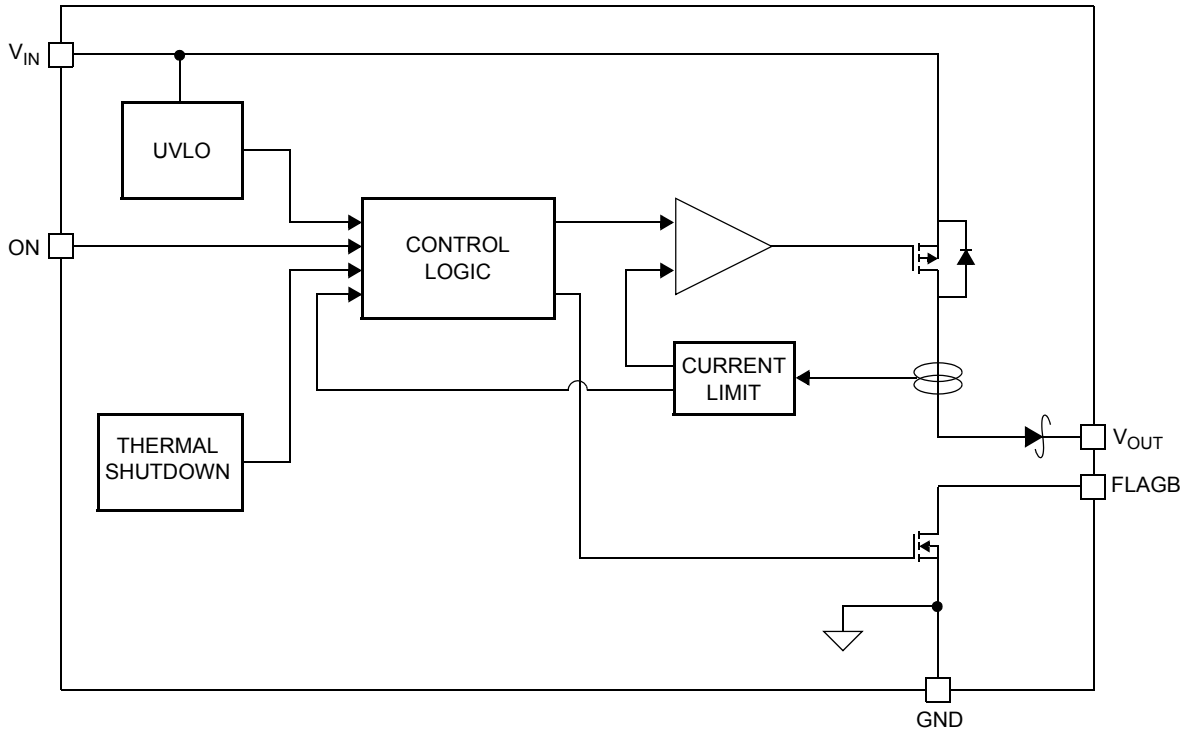

### Pin Configuration

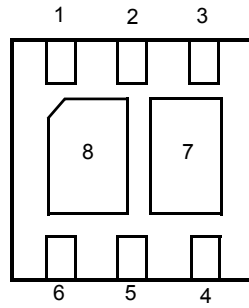

3x3 MLP BOTTOM VIEW

### Pin Description

Pin	Name	Function
1	V <sub>IN</sub>	Supply Input: Input to the power switch and the supply voltage for the IC
2, 8	NC	No Connect
3, 7	V <sub>OUT</sub>	Switch Output: Output of the power switch
4	FLAGB	Fault Output: Active LO, open drain output which indicates an over current supply, under voltage or over temperature state.
5	GND	Ground
6	ON	ON Control Input

## Absolute Maximum Ratings

Parameter		Min	Max	Unit
$V_{IN}$ , ON, FLAGB to GND		-0.3	6	V
$V_{OUT}$ to GND		-0.3	20	V
Power Dissipation @ $T_A = 25^\circ\text{C}$ (note 1)		-	1.4	W
Operating Temperature Range		-40	85	$^\circ\text{C}$
Storage Temperature		-65	150	$^\circ\text{C}$
Thermal Resistance, Junction to Ambient		-	70	$^\circ\text{C/W}$
Electrostatic Discharge Protection	HBM	4000	-	V
	MM	400	-	V

## Recommended Operating Range

Parameter		Min	Max	Unit
$V_{IN}$		1.8	5.5	V
Ambient Operating Temperature, $T_A$		-40	85	$^\circ\text{C}$

## Electrical Characteristics

$V_{IN} = 1.8$  to  $5.5\text{V}$ ,  $T_A = -40$  to  $+85^\circ\text{C}$  unless otherwise noted. Typical values are at  $V_{IN} = 3.3\text{V}$  and  $T_A = 25^\circ\text{C}$ .

Parameter	Symbol	Conditions	Min	Typ	Max	Units	
<b>Basic Operation</b>							
Operating Voltage	$V_{IN}$		1.8	-	5.5	V	
Quiescent Current	$I_Q$	$I_{OUT} = 0\text{mA}$ $V_{ON}$ ACTIVE	$V_{IN} = 1.8$ to $3.3\text{V}$	-	95	-	$\mu\text{A}$
			$V_{IN} = 3.3$ to $5.5\text{V}$	-	110	200	
Shutdown Current	$I_{SHDN}$		-	-	1	$\mu\text{A}$	
Latch-off Current	$I_{LATCHOFF}$	$V_{ON} = V_{IN}$ , after and overcurrent fault	-	50	-	$\mu\text{A}$	
Reverse Block Leakage Current	$I_R$	$V_{OUT} = 20\text{V}$ , $V_{IN} = V_{ON} = 0\text{V}$ , $T_A = 25^\circ\text{C}$	-	10	100	$\mu\text{A}$	
Reverse Breakdown Voltage		$I_{OUT} = 250\text{mA}$	20	-	-	V	
Dropout Voltage	$V_{DROP}$	$T_A = 25^\circ\text{C}$ , $I_{OUT} = 150\text{mA}$	-	0.3	0.4	V	
		$T_A = 85^\circ\text{C}$ , $I_{OUT} = 150\text{mA}$		0.23	-		
		$T_A = -40^\circ\text{C}$ , $I_{OUT} = 150\text{mA}$	-	0.36	-		
ON Input Logic High Voltage (ON)	$V_{IH}$	$V_{IN} = 1.8\text{V}$	0.75	-	-	V	
		$V_{IN} = 5.5\text{V}$	1.3	-	-		
ON Input Logic Low Voltage	$V_{IL}$	$V_{IN} = 1.8\text{V}$	-	-	0.5	V	
		$V_{IN} = 5.5\text{V}$	-	-	1.0		
ON Input Leakage		$V_{ON} = V_{IN}$ or GND	-	-	1	$\mu\text{A}$	
Off Switch Leakage	$I_{SWOFF}$	$V_{ON} = 0\text{V}$ , $V_{OUT} = 0\text{V}$ @ $V_{IN} = 5.5\text{V}$ , $T_A = 85^\circ\text{C}$			1	$\mu\text{A}$	
		$V_{ON} = 0\text{V}$ , $V_{OUT} = 0\text{V}$ @ $V_{IN} = 3.3\text{V}$ , $T_A = 25^\circ\text{C}$		10	100	nA	
FLAGB Output Logic Low Voltage		$V_{IN} = 5\text{V}$ , $I_{SINK} = 10\text{mA}$	-	-	0.2	V	
		$V_{IN} = 1.8\text{V}$ , $I_{SINK} = 10\text{mA}$	-	-	0.3		
FLAGB Output High Leakage Current		$V_{IN} = 5\text{V}$ , Switch on	-	-	1	$\mu\text{A}$	

## Electrical Characteristics Cont.

$V_{IN} = 1.8$  to  $5.5V$ ,  $T_A = -40$  to  $+85^{\circ}C$  unless otherwise noted. Typical values are at  $V_{IN} = 3.3V$  and  $T_A = 25^{\circ}C$ .

Parameter	Symbol	Conditions	Min	Typ	Max	Units
<b>Protections</b>						
Current Limit	$I_{LIM}$	$V_{IN} = 3.3V$ , $V_{OUT} = 2.0V$	200	300	400	mA
Thermal Shutdown		Shutdown Threshold	-	140	-	$^{\circ}C$
		Return from Shutdown	-	130	-	
		Hysteresis	-	10	-	
Under Voltage Shutdown	UVLO	$V_{IN}$ Increasing	1.5	1.6	1.7	V
Under Voltage Shutdown Hysteresis			-	47	-	mV
<b>Dynamic</b>						
Turn on time	$t_{ON}$	$R_L = 500\Omega$ , $C_L = 0.1\mu F$	-	22	-	$\mu s$
Turn off time	$t_{OFF}$	$R_L = 500\Omega$ , $C_L = 0.1\mu F$	-	20	-	$\mu s$
$V_{OUT}$ Rise Time	$t_R$	$R_L = 500\Omega$ , $C_L = 0.1\mu F$	-	13	-	$\mu s$
$V_{OUT}$ Fall Time	$t_F$	$R_L = 500\Omega$ , $C_L = 0.1\mu F$	-	117	-	$\mu s$
Over Current Blanking Time	$t_{BLANK}$		5	10	20	ms
Short Circuit Response Time		$V_{IN} = V_{ON} = 3.3V$ . Moderate Over-Current Condition.	-	3	-	$\mu s$
		$V_{IN} = V_{ON} = 3.3V$ . Hard Short.	-	20	-	ns

**Note 1:** Package power dissipation on 1 square inch pad, 2 oz. copper board.

### Typical Characteristics

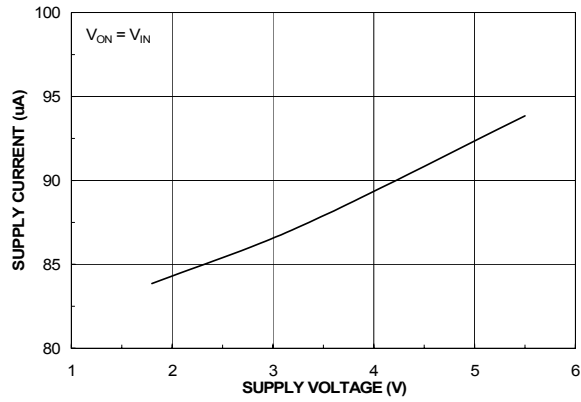

Figure 1. Quiescent Current vs. Input Voltage

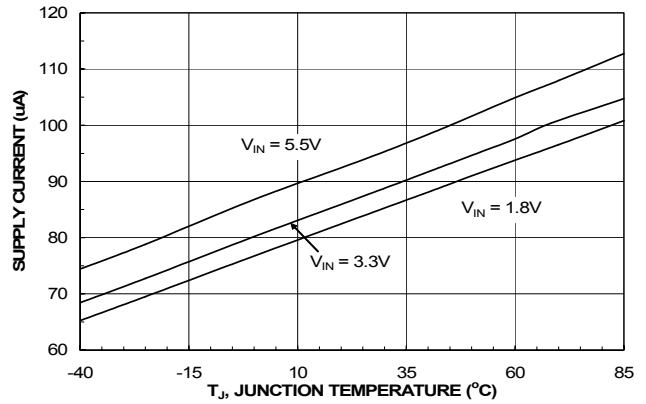

Figure 2. Quiescent Current vs. Temperature

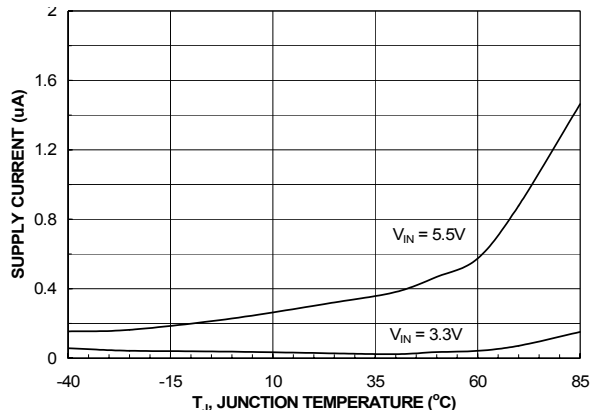

Figure 3. I<sub>SHUTDOWN</sub> Current vs. Temperature

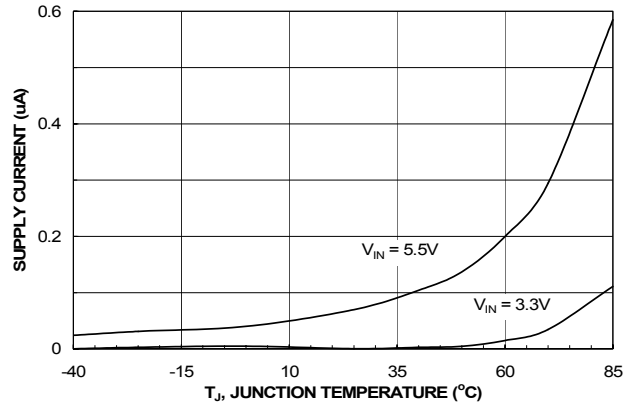

Figure 4. I<sub>SWITCH-OFF</sub> Current vs. Temperature

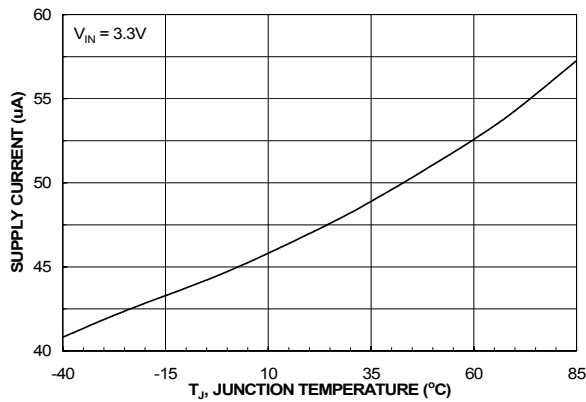

Figure 5. Latchoff current vs. Temperature

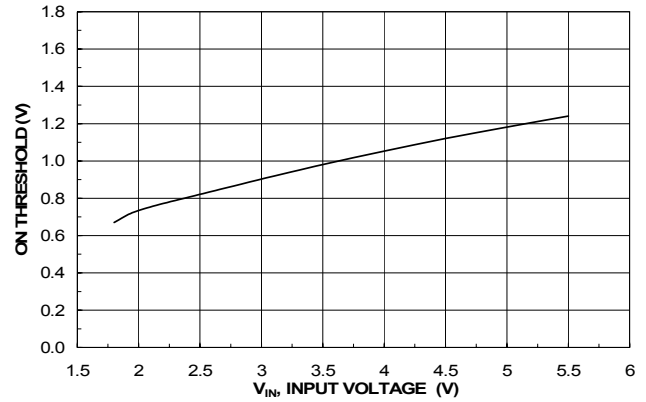

Figure 6. Input Voltage vs. On Threshold Voltage

### Typical Characteristics

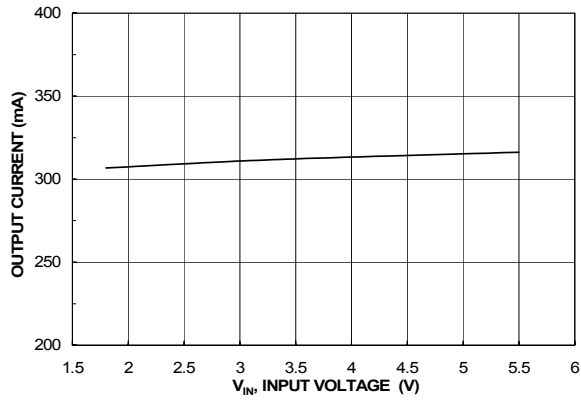

Figure 7. Current Limit vs. Output Voltage

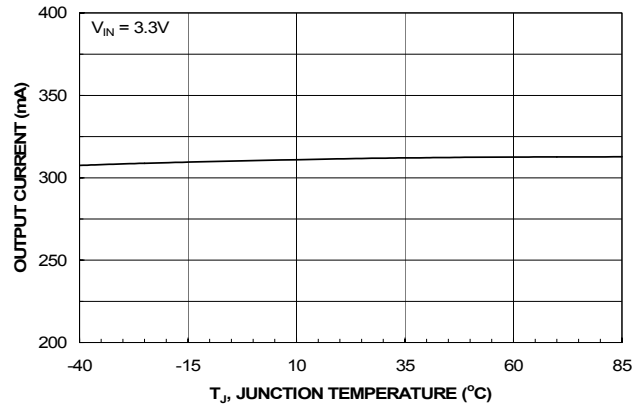

Figure 8. Current Limit vs. Temperature

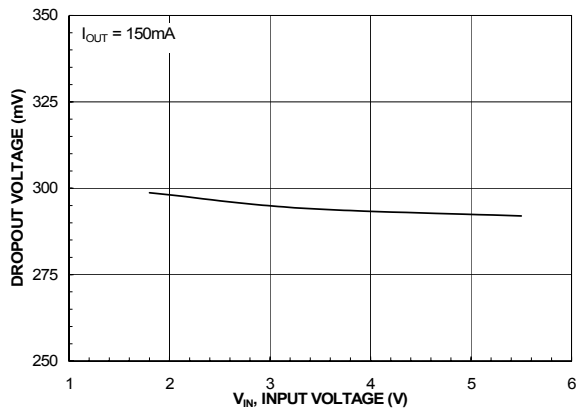

Figure 9. Drop Voltage vs. Input Voltage

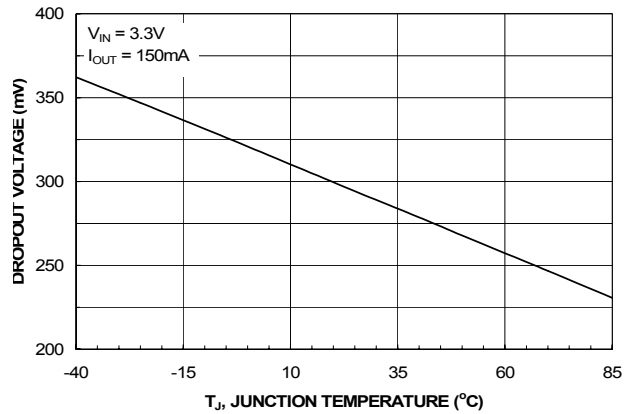

Figure 10. Drop Voltage vs. Temperature

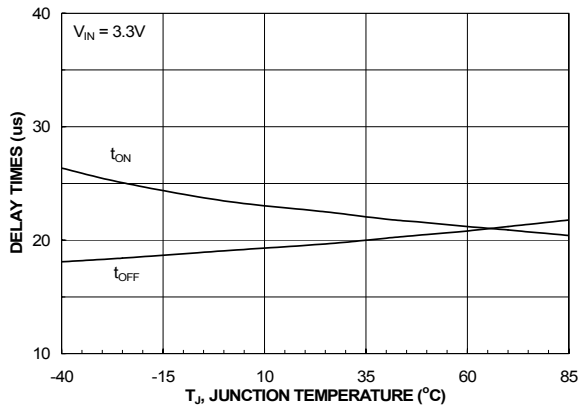

Figure 11.  $T_{ON}/T_{Off}$  vs. Temperature

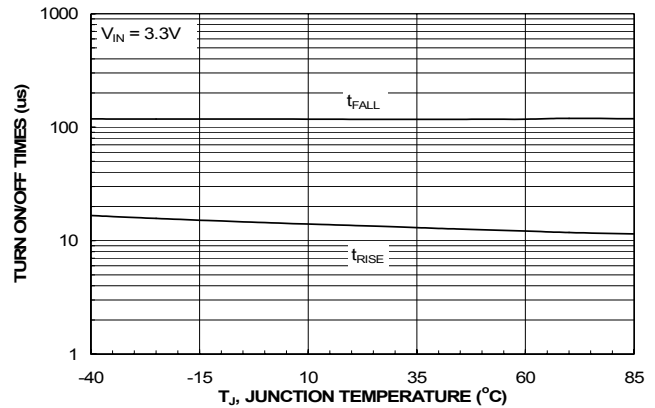

Figure 12.  $T_{RISE}/T_{FALL}$  vs. Temperature

## Typical Characteristics

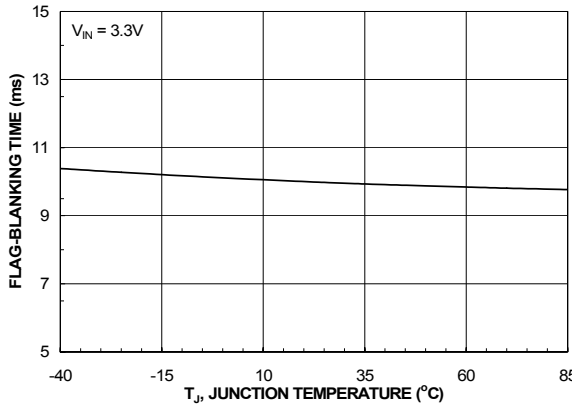

Figure 13.  $T_{BLANK}$  vs. Temperature

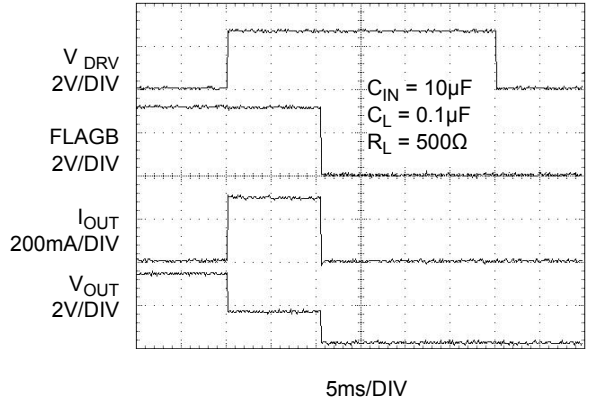

Figure 14.  $T_{BLANK}$  Response

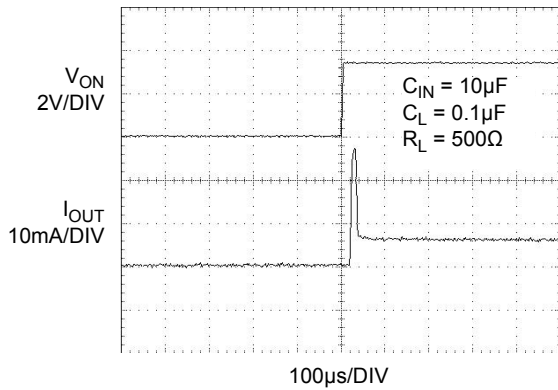

Figure 15.  $T_{ON}$  Response

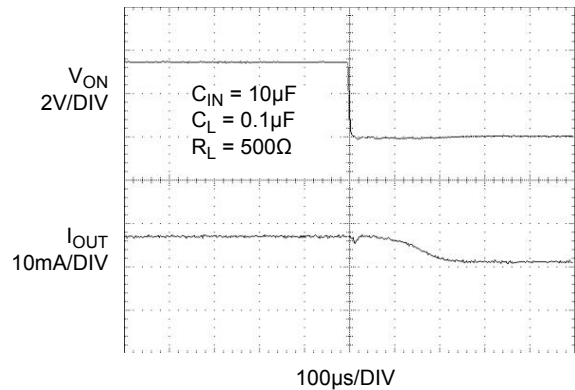

Figure 16.  $T_{OFF}$  Response

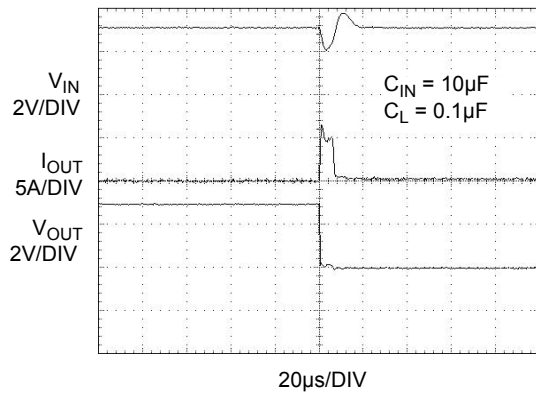

Figure 17. Short Circuit Response Time  
(Output Shorted to GND)

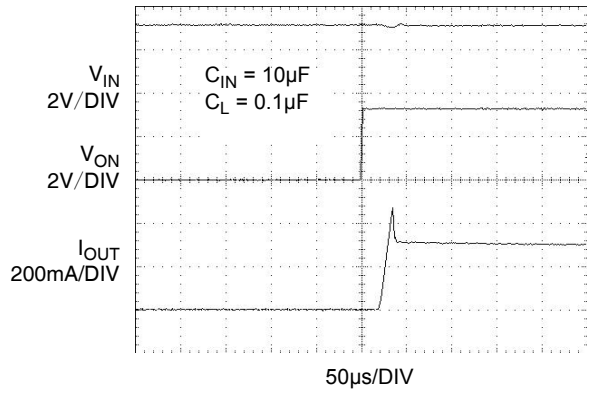

Figure 18. Current Limit Response Time  
(Output has a 4.7Ω load)

## Description of Operation

The FPF2172 is a current limited switch that protects systems and loads which can be damaged or disrupted by the application of high currents. The core of the device is a 0.125Ω P-channel MOSFET and a controller capable of functioning over a wide input operating range of 1.8-5.5V paired with a low forward voltage drop Schottky diode for reverse blocking. The controller protects against system malfunctions through current limiting, under-voltage lockout and thermal shutdown. The current limit is preset for 200mA.

## On/Off Control

The ON pin controls the state of the switch. Activating ON continuously holds the switch in the on state so long as there is no under-voltage on  $V_{IN}$  or a junction temperature in excess of 150°C. ON is active HI and has a low threshold making it capable of interfacing with low voltage signals. When the MOSFET is off, the Schottky diode acts as a barrier so that no reverse current can flow when  $V_{OUT}$  is greater than  $V_{IN}$ .

## Fault Reporting

Upon the detection of an over-current, an input under-voltage, or an over-temperature condition, the FLAGB signals the fault mode by activating LO. The FLAGB goes LO at the end of the blanking time and is latched LO and ON must be toggled to release it. FLAGB is an open-drain MOSFET which requires a pull-up resistor between  $V_{IN}$  and FLAGB. During shutdown, the pull-down on FLAGB is disabled to reduce current draw from the supply.

## Current Limiting

The current limit guarantees that the current through the switch doesn't exceed a maximum value while not limiting at less than a minimum value. The minimum current is 200mA and the maximum current is 400mA. The device has a blanking time of 10ms, nominally, during which the switch will act as a constant current source. At the end of the blanking time, the switch will be turned-off and the FLAGB pin will activate to indicate that current limiting has occurred.

## Under-Voltage Lockout

The under-voltage lockout turns-off the switch if the input voltage drops below the under-voltage lockout threshold. With the ON pin active the input voltage rising above the under-voltage lockout threshold will cause a controlled turn-on of the switch which limits current over-shoots.

## Thermal Shutdown

The thermal shutdown protects the die from internally or externally generated excessive temperatures. During an over-temperature condition the FLAGB is activated and the switch is turned-off. The switch automatically turns-on again if temperature of the die drops below the threshold temperature.



## Application Information

### Typical Application

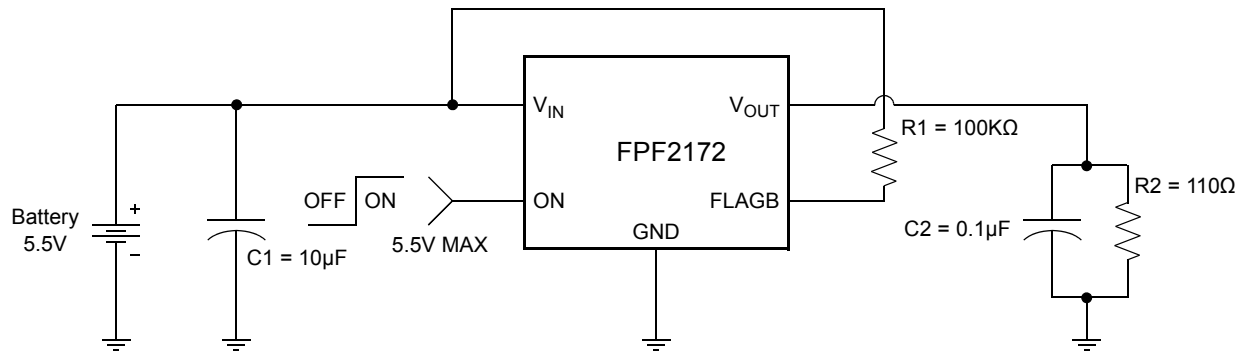

### Input Capacitor

To limit the voltage drop on the input supply caused by transient in-rush currents when the switch turns-on into a discharged load capacitor or a short-circuit, a capacitor needs to be placed between  $V_{IN}$  and GND. A  $0.1\mu\text{F}$  ceramic capacitor,  $C_{IN}$ , placed close to the pins is usually sufficient. Higher values of  $C_{IN}$  can be used to further reduce the voltage drop.

### Output Capacitor

A  $0.1\mu\text{F}$  capacitor  $C_{OUT}$ , should be placed between  $V_{OUT}$  and GND. This capacitor will prevent parasitic board inductances from forcing  $V_{OUT}$  below GND when the switch turns-off.

### Power Dissipation

During normal operation as a switch, the power dissipation is small and has little effect on the operating temperature of the part. The parts with the higher current limits will dissipate the most power and that will only be typically,

$$P = I_{LIM} \times V_{DROP} = 0.4 \times 0.4 = 160\text{mW} \quad (1)$$

When using the part, attention must be given to the manual resetting of the part. Continuously resetting the part at a high duty cycle when a short on the output is present can cause the temperature of the part to increase. The junction temperature will only be allowed to increase to the thermal shutdown threshold. Once this temperature has been reached, toggling ON will not turn-on the switch until the junction temperature drops.

### Board Layout

For best performance, all traces should be as short as possible. To be most effective, the input and output capacitors should be placed close to the device to minimize the effects that parasitic trace inductances may have on normal and short-circuit operation. Using wide traces for  $V_{IN}$ ,  $V_{OUT}$  and GND will help minimize parasitic electrical effects along with minimizing the case to ambient thermal impedance.

# Dimensional Outline and Pad Layout

## Package MLP06H

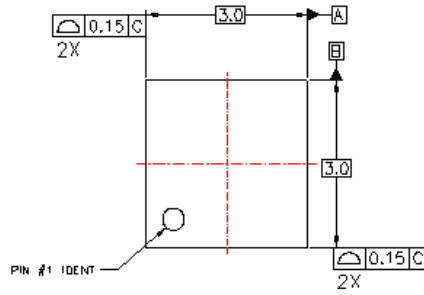

TOP VIEW

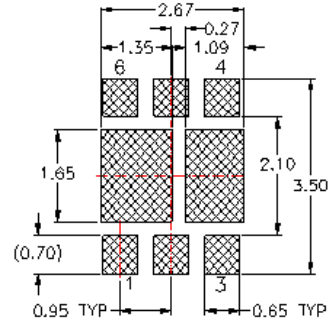

RECOMMENDED LAND PATTERN

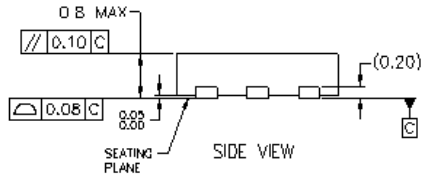

SIDE VIEW

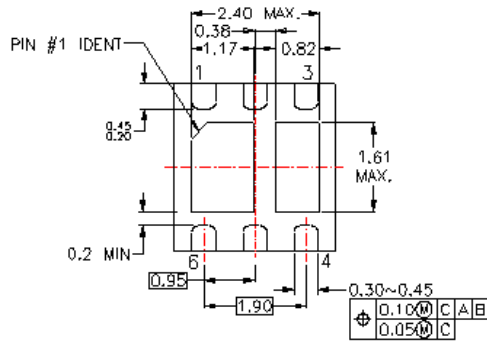

BOTTOM VIEW

NOTES:

- A. CONFORMS TO JEDEC REGISTRATION MO-229, VARIATION WEEA, DATED 11/2001
- B. DIMENSIONS ARE IN MILLIMETERS.
- C. DIMENSIONS AND TOLERANCES PER ASME Y14.5M, 1994

MLP06HrevA



## TRADEMARKS

The following are registered and unregistered trademarks and service marks Fairchild Semiconductor owns or is authorized to use and is not intended to be an exhaustive list of all such trademarks.

ACEx <sup>®</sup>	Green FPS <sup>™</sup>	Power247 <sup>®</sup>	SuperSOT <sup>™</sup> -8
Build it Now <sup>™</sup>	Green FPS <sup>™</sup> e-Series <sup>™</sup>	POWEREDGE <sup>®</sup>	SyncFET <sup>™</sup>
CorePLUS <sup>™</sup>	GTO <sup>™</sup>	Power-SPM <sup>™</sup>	The Power Franchise <sup>®</sup>
CROSSVOLT <sup>™</sup>	<i>i-Lo</i> <sup>™</sup>	PowerTrench <sup>®</sup>	the <b>power</b> franchise
CTL <sup>™</sup>	IntelliMAX <sup>™</sup>	Programmable Active Droop <sup>™</sup>	TinyBoost <sup>™</sup>
Current Transfer Logic <sup>™</sup>	ISOPLANAR <sup>™</sup>	QFET <sup>®</sup>	TinyBuck <sup>™</sup>
EcoSPARK <sup>®</sup>	MegaBuck <sup>™</sup>	QS <sup>™</sup>	TinyLogic <sup>®</sup>
<b>F</b> <sup>®</sup>	MICROCOUPLER <sup>™</sup>	QT Optoelectronics <sup>™</sup>	TINYOPTO <sup>™</sup>
Fairchild <sup>®</sup>	MicroFET <sup>™</sup>	Quiet Series <sup>™</sup>	TinyPower <sup>™</sup>
Fairchild Semiconductor <sup>®</sup>	MicroPak <sup>™</sup>	RapidConfigure <sup>™</sup>	TinyPWM <sup>™</sup>
FACT Quiet Series <sup>™</sup>	Motion-SPM <sup>™</sup>	SMART START <sup>™</sup>	TinyWire <sup>™</sup>
FACT <sup>®</sup>	OPTOLOGIC <sup>®</sup>	SPM <sup>®</sup>	μSerDes <sup>™</sup>
FAST <sup>®</sup>	OPTOPLANAR <sup>®</sup>	STEALTH <sup>™</sup>	UHC <sup>®</sup>
FastvCore <sup>™</sup>	 <sup>®</sup>	SuperFET <sup>™</sup>	UniFET <sup>™</sup>
FPS <sup>™</sup>	PDP-SPM <sup>™</sup>	SuperSOT <sup>™</sup> -3	VCX <sup>™</sup>
FRFET <sup>®</sup>	Power220 <sup>®</sup>	SuperSOT <sup>™</sup> -6	
Global Power Resource <sup>SM</sup>			

## DISCLAIMER

FAIRCHILD SEMICONDUCTOR RESERVES THE RIGHT TO MAKE CHANGES WITHOUT FURTHER NOTICE TO ANY PRODUCTS HEREIN TO IMPROVE RELIABILITY, FUNCTION, OR DESIGN. FAIRCHILD DOES NOT ASSUME ANY LIABILITY ARISING OUT OF THE APPLICATION OR USE OF ANY PRODUCT OR CIRCUIT DESCRIBED HEREIN; NEITHER DOES IT CONVEY ANY LICENSE UNDER ITS PATENT RIGHTS, NOR THE RIGHTS OF OTHERS. THESE SPECIFICATIONS DO NOT EXPAND THE TERMS OF FAIRCHILD'S WORLDWIDE TERMS AND CONDITIONS, SPECIFICALLY THE WARRANTY THEREIN, WHICH COVERS THESE PRODUCTS.

## LIFE SUPPORT POLICY

FAIRCHILD'S PRODUCTS ARE NOT AUTHORIZED FOR USE AS CRITICAL COMPONENTS IN LIFE SUPPORT DEVICES OR SYSTEMS WITHOUT THE EXPRESS WRITTEN APPROVAL OF FAIRCHILD SEMICONDUCTOR CORPORATION.

As used herein:

- Life support devices or systems are devices or systems which, (a) are intended for surgical implant into the body, or (b) support or sustain life, and (c) whose failure to perform when properly used in accordance with instructions for use provided in the labeling, can be reasonably expected to result in significant injury to the user.
- A critical component is any component of a life support device or system whose failure to perform can be reasonably expected to cause the failure of the life support device or system, or to affect its safety or effectiveness.

## PRODUCT STATUS DEFINITIONS

### Definition of Terms

Datasheet Identification	Product Status	Definition
Advance Information	Formative or In Design	This datasheet contains the design specifications for product development. Specifications may change in any manner without notice.
Preliminary	First Production	This datasheet contains preliminary data; supplementary data will be published at a later date. Fairchild Semiconductor reserves the right to make changes at any time without notice to improve design.
No Identification Needed	Full Production	This datasheet contains final specifications. Fairchild Semiconductor reserves the right to make changes at any time without notice to improve design.
Obsolete	Not In Production	This datasheet contains specifications on a product that has been discontinued by Fairchild semiconductor. The datasheet is printed for reference information only.

Rev. I30