

FPF1007-FPF1009 IntelliMAX™ Advanced Load Products

Features

- 1.2 to 5.5V Input Voltage Range
- Typical $R_{ON} = 30\text{ m}\Omega @ V_{IN} = 5.5\text{V}$
- Typical $R_{ON} = 40\text{ m}\Omega @ V_{IN} = 3.3\text{V}$
- Fixed Three Different Turn-on Rise-time 10 μs /80 μs /1ms
- Low < 10 μA @ $V_{IN} = 3.3\text{V}$ Quiescent Current
- Internal ON Pin Pull Down
- Output Discharge Function
- ESD Protection above 8000V HBM and 2000V CDM
- RoHS Compliant

Applications

- PDAs
- Cell Phones
- GPS Devices
- MP3 Players
- Digital Cameras
- Peripheral Ports
- Hot Swap Supplies
- Notebook Computer



General Description

The FPF1007/8/9 are low RDS P-Channel MOSFET load switches offered in a selection of 10 μs , 80 μs , and 1ms slew rate turn-on options for transient/in-rush current control. To support trends in mobile application requirements the minimum operating input voltage has been reduced down to 1.2V, the input current leakage has been minimized to extend battery life, and the ESD-protection has been designed to withstand a minimum of 8KV (HBM) and 2KV(CDM).

The switch is controlled by an active-high logic input (ON pin) allowing it to interface directly with a low voltage control signal. An internal ON pin pull down resistor protects against an unintentional device turn-on while in the initial state. An On-chip pull-down resistor on the output is enabled when the switch is turned-off and provides a quick and robust discharge of the output load.

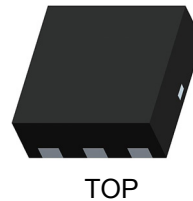
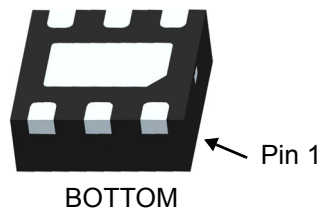

Ordering Information

Part	Switch $R_{ON} @ 5.5\text{V}$ [Typ.]	Rise Time [Typ.]	Output Discharge [Typ.]	ON Pin Activity
FPF1007	30m Ω , PMOS	10 μs	60 Ω	Active HI
FPF1008	30m Ω , PMOS	80 μs	60 Ω	Active HI
FPF1009	30m Ω , PMOS	1ms	60 Ω	Active HI

Typical Application Circuit

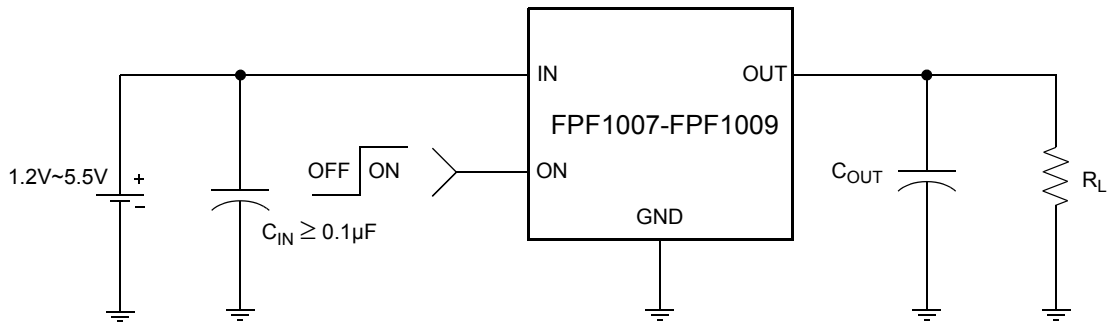

Functional Block Diagram

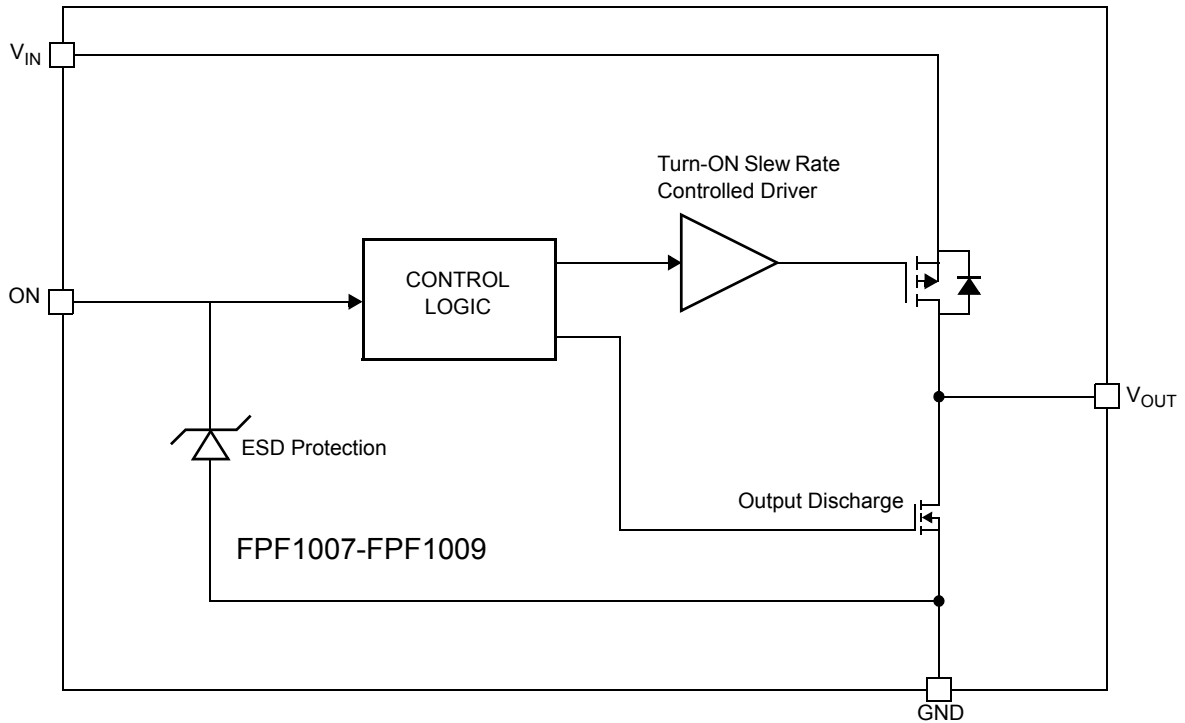

Pin Configuration

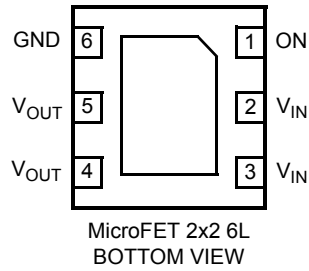

Pin Description

Pin	Name	Function
4, 5	V_{OUT}	Switch Output: Output of the power switch
2, 3	V_{IN}	Supply Input: Input to the power switch and the supply voltage for the IC
6	GND	Ground
1	ON	ON/OFF Control Input

Absolute Maximum Ratings

Parameter	Min.	Max.	Unit
V_{IN} , V_{OUT} , ON to GND	-0.3	6	V
Maximum Continuous Switch Current		1.5	A
Power Dissipation @ $T_A = 25^\circ\text{C}$ (Note 1)		1.2	W
Storage Junction Temperature	-65	150	$^\circ\text{C}$
Operating Temperature Range	-40	85	$^\circ\text{C}$
Thermal Resistance, Junction to Ambient		86	$^\circ\text{C}/\text{W}$
Electrostatic Discharge Protection	HBM	8000	V
	CDM	2000	V

Recommended Operating Range

Parameter	Min.	Max.	Unit
V_{IN}	1.2	5.5	V
Ambient Operating Temperature, T_A	-40	85	$^\circ\text{C}$

Electrical Characteristics

$V_{IN} = 1.2$ to 5.5V , $T_A = -40$ to $+85^\circ\text{C}$ unless otherwise noted. Typical values are at $V_{IN} = 3.3\text{V}$ and $T_A = 25^\circ\text{C}$.

Parameter	Symbol	Conditions	Min.	Typ.	Max.	Units
Basic Operation						
Operating Voltage	V_{IN}		1.2		5.5	V
Quiescent Current	I_Q	$I_{OUT} = 0\text{mA}$, $V_{IN} = 3.3\text{V}$, $V_{ON} = \text{Enabled}$		8		μA
		$I_{OUT} = 0\text{mA}$, $V_{IN} = 5.5\text{V}$, $V_{ON} = \text{Enabled}$			15	
Off Supply Current	$I_{Q(\text{off})}$	$V_{ON} = \text{GND}$, $V_{OUT} = \text{OPEN}$			1	μA
Off Switch Current	$I_{SD(\text{off})}$	$V_{ON} = \text{GND}$, $V_{OUT} = \text{GND}$		0.1	1	μA

Electrical Characteristics Cont.

$V_{IN} = 1.2$ to $5.5V$, $T_A = -40$ to $+85^\circ C$ unless otherwise noted. Typical values are at $V_{IN} = 3.3V$ and $T_A = 25^\circ C$.

Parameter	Symbol	Conditions	Min.	Typ.	Max.	Units
On-Resistance	R_{ON}	$V_{IN} = 5.5V, I_{OUT} = 200mA, T_A = 25^\circ C$		30	40	m Ω
		$V_{IN} = 3.3V, I_{OUT} = 200mA, T_A = 25^\circ C$		40	55	
		$V_{IN} = 1.5V, I_{OUT} = 200mA, T_A = 25^\circ C$		100	130	
		$V_{IN} = 1.2V, I_{OUT} = 200mA, T_A = 25^\circ C$		175	250	
		$V_{IN} = 3.3V, I_{OUT} = 200mA, T_A = -40^\circ C$ to $+85^\circ C$	20		65	
Output Pull Down Resistance	R_{PD}	$V_{IN} = 3.3V, V_{ON} = 0V, T_A = 25^\circ C$		60		Ω
ON Input Logic Low Voltage	V_{IL}	$V_{IN} = 1.2V$ to $5.5V$			0.4	V
ON Input Logic High Voltage	V_{IH}	$V_{IN} = 1.2V$ to $5.5V$	1			V
ON Input Leakage (On)		$V_{ON} = V_{IN} = 5.5V$	-1		10	μA
ON Input Leakage (Off)		$V_{ON} = GND$	-1		1	μA
Dynamic						
FPF1007						
Turn On	t_{ON}	$V_{IN} = 3.3V, R_L = 500\Omega, R_{L_CHIP} = 60\Omega,$ $C_{OUT} = 0.1\mu F, T_A = 25^\circ C$		12		μs
Rise Time	t_R			10		μs
Turn Off	t_{OFF}			40		μs
Fall Time	t_F			15		μs
FPF1008						
Turn On	t_{ON}	$V_{IN} = 3.3V, R_L = 500\Omega, R_{L_CHIP} = 60\Omega,$ $C_{OUT} = 0.1\mu F, T_A = 25^\circ C$		125		μs
Rise Time	t_R			80		μs
Turn Off	t_{OFF}			40		μs
Fall Time	t_F			15		μs
FPF1009						
Turn On	t_{ON}	$V_{IN} = 3.3V, R_L = 500\Omega, R_{L_CHIP} = 60\Omega,$ $C_{OUT} = 0.1\mu F, T_A = 25^\circ C$		2		ms
Rise Time	t_R			1		ms
Turn Off	t_{OFF}			40		μs
Fall Time	t_F			15		μs

Note 1: Package power dissipation on 1square inch pad, 2 oz. copper board.

Typical Characteristics

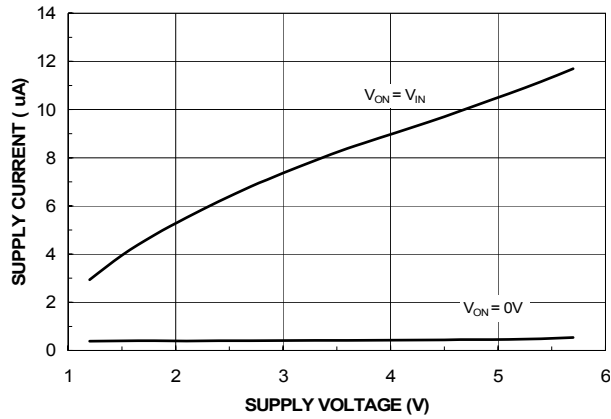

Figure 1. Quiescent Current vs. Input Voltage

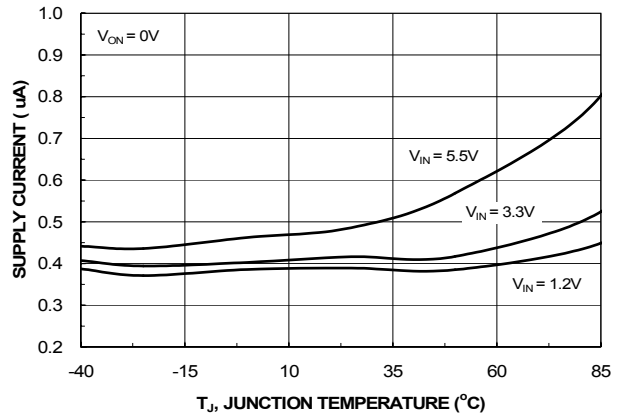

Figure 2. Quiescent Current vs. Temperature

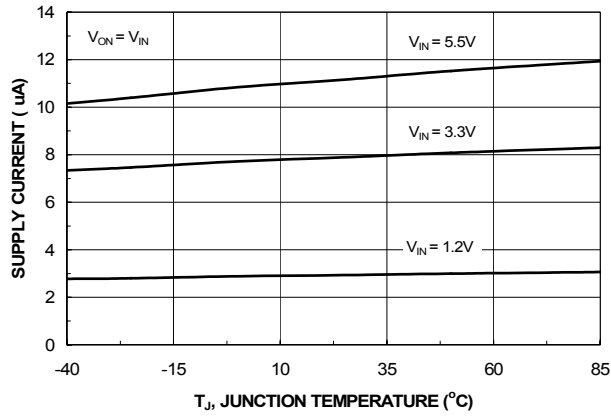

Figure 3. Quiescent Current vs. Temperature

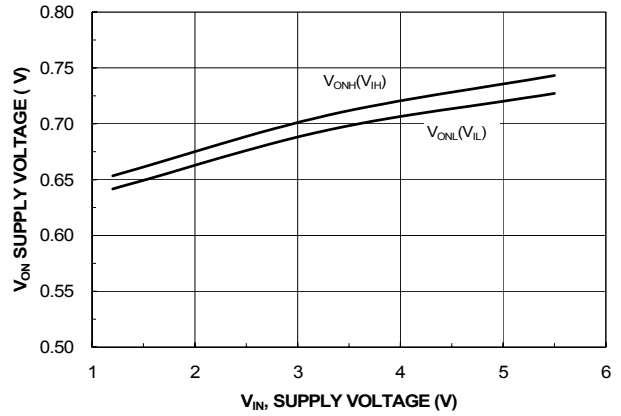

Figure 4. V_{ON} Voltage vs. Input Voltage

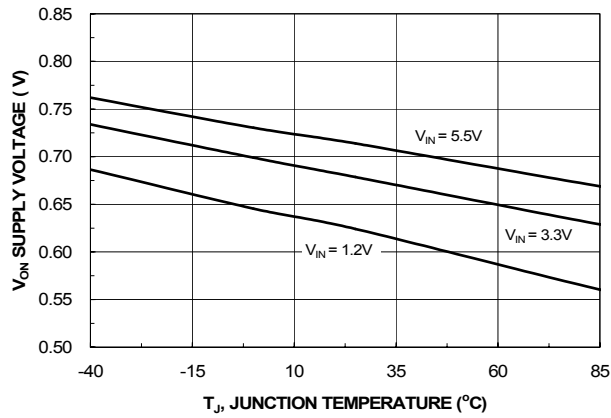

Figure 5. V_{ON} Low Voltage vs. Temperature

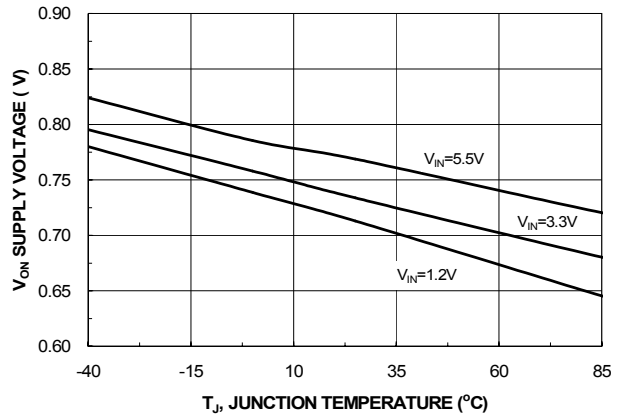

Figure 6. V_{ON} High Voltage vs. Temperature

Typical Characteristics

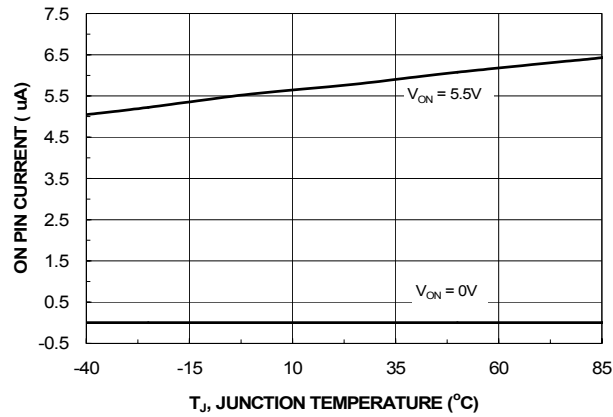

Figure 7. On Pin Current vs. Temperature

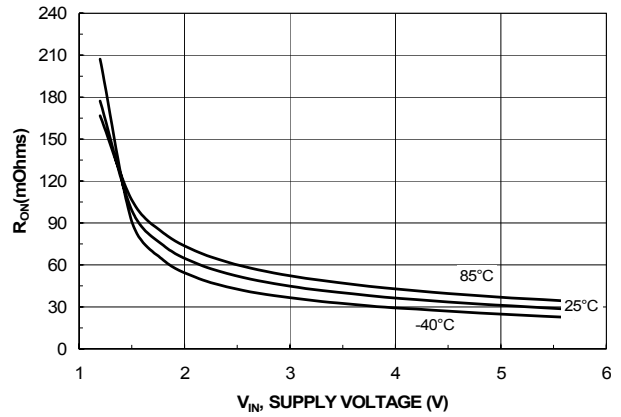

Figure 8. R_{ON} vs. V_{IN}

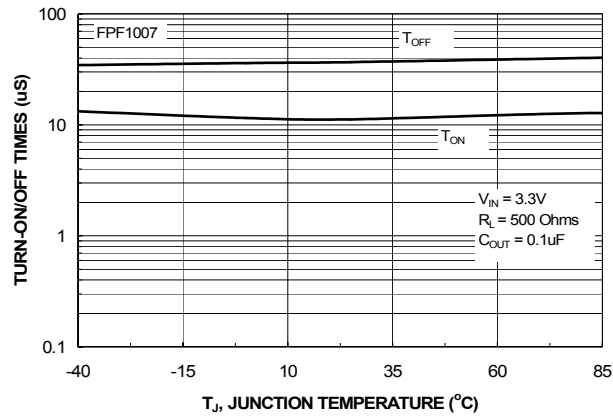

Figure 9. FPF1007 T_{ON} / T_{OFF} vs. Temperature

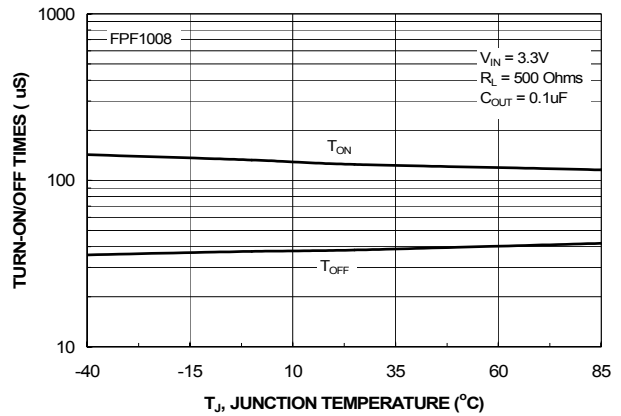

Figure 10. FPF1008 T_{ON} / T_{OFF} vs. Temperature

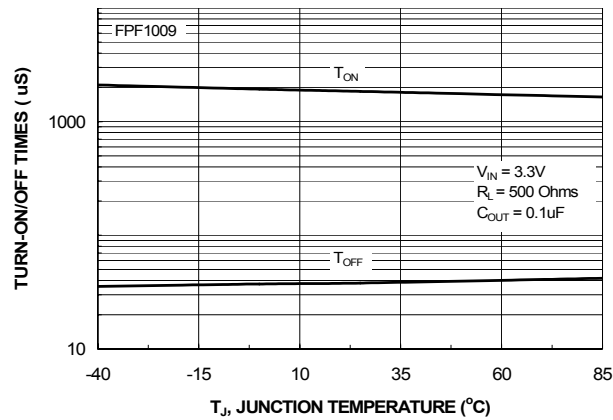

Figure 11. FPF1009 T_{ON} / T_{OFF} vs. Temperature

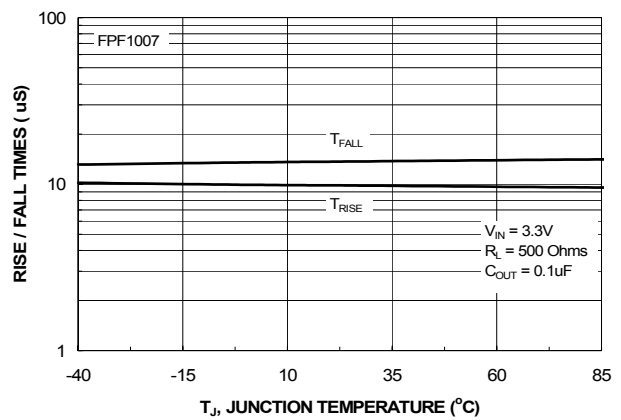

Figure 12. FPF1007 T_{RISE} / T_{FALL} vs. Temperature

Typical Characteristics

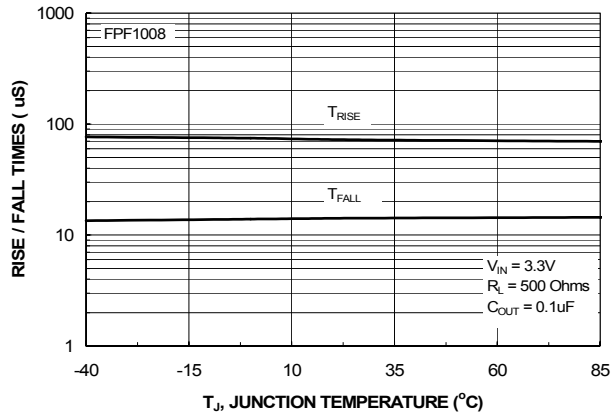

Figure 13. FPF1008 T_{RISE} / T_{FALL} vs. Temperature

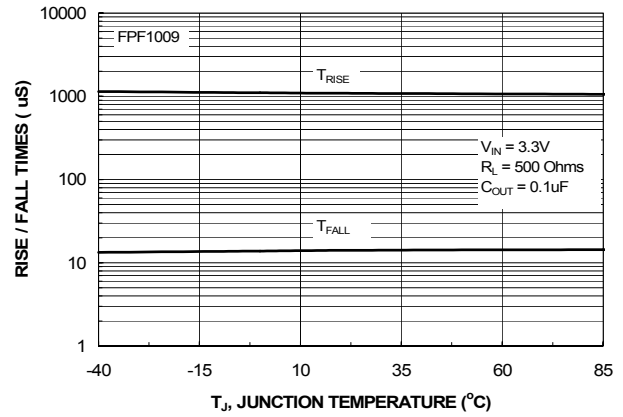

Figure 14. FPF1009 T_{RISE} / T_{FALL} vs. Temperature

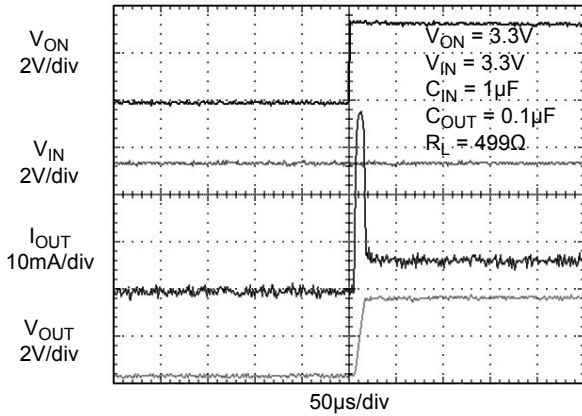

Figure 15. FPF1007 Turn ON Response

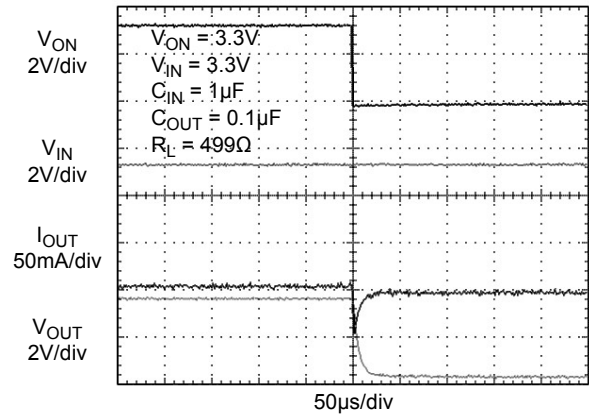

Figure 16. FPF1007 Turn OFF Response
Load current is discharged through On-chip output discharge resistor.

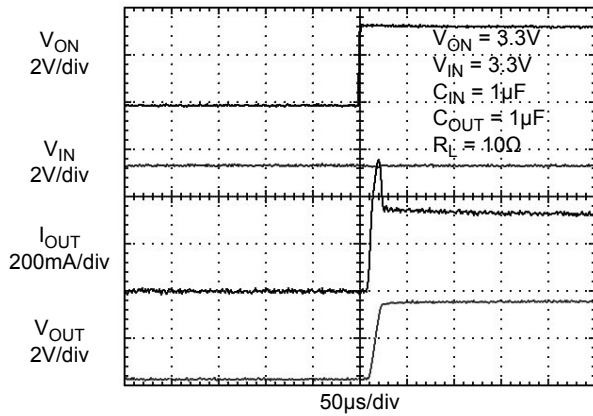

Figure 17. FPF1007 Turn ON Response ($C_{OUT} = 1\mu F$)

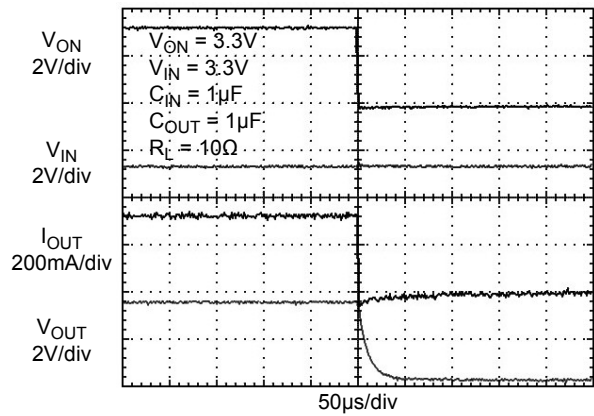

Figure 18. FPF1007 Turn OFF Response

Typical Characteristics

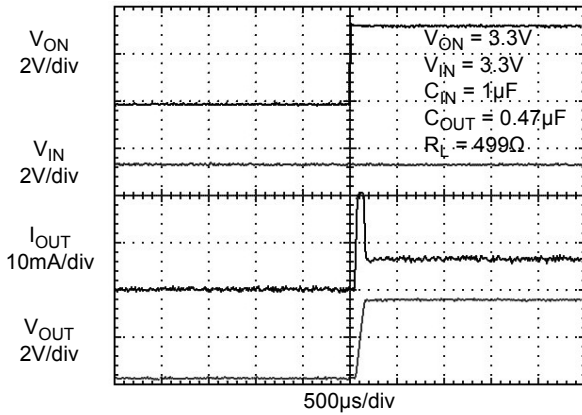

Figure 19. FPF1008 Turn ON Response

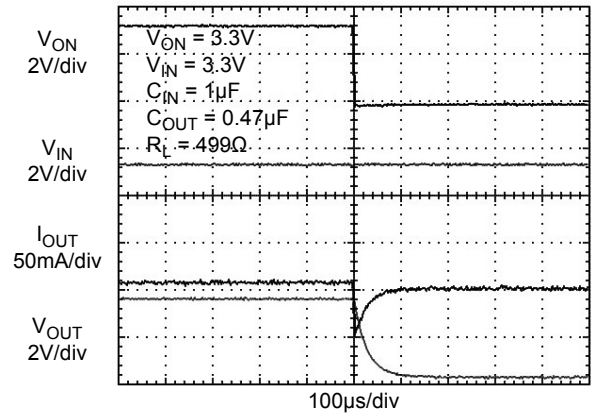

Figure 20. FPF1008 Turn OFF Response
Load current is discharged through On-chip output discharge resistor.

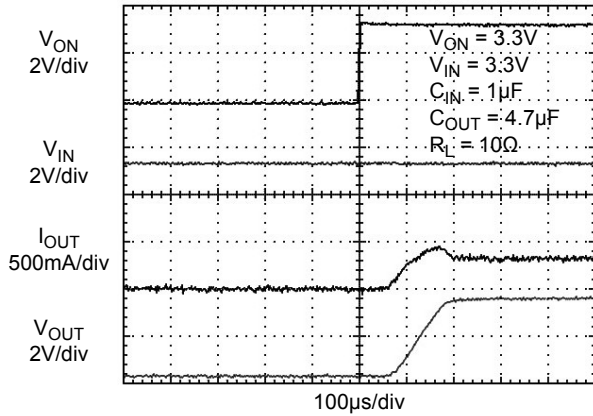

Figure 21. FPF1008 Turn ON Response ($C_{OUT} = 4.7\mu F$)

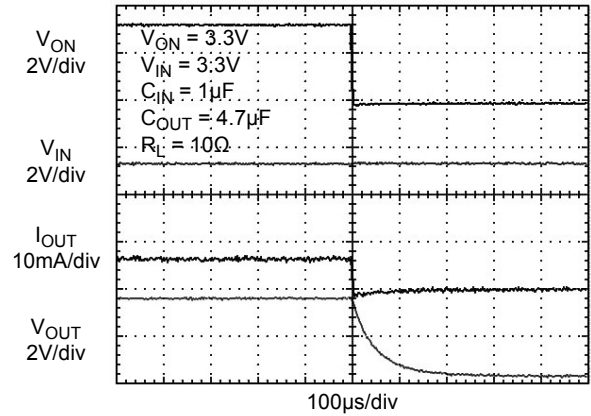

Figure 22. FPF1008 Turn OFF Response

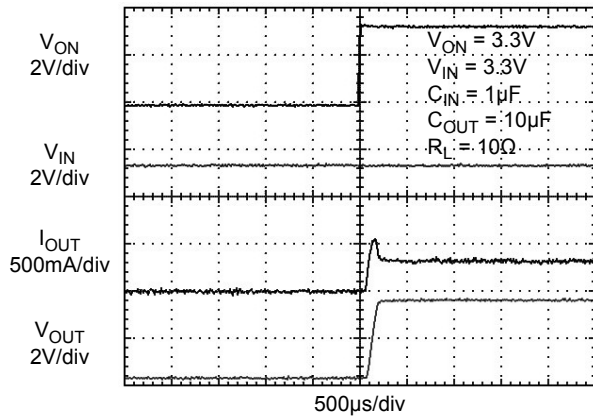

Figure 23. FPF1008 Turn ON Response ($C_{OUT} = 10\mu F$)

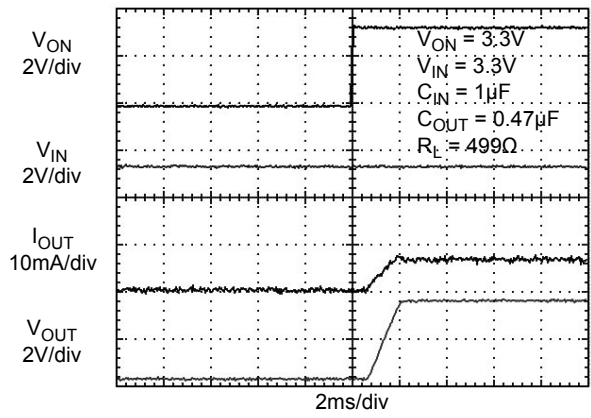

Figure 24. FPF1009 Turn ON Response

Typical Characteristics

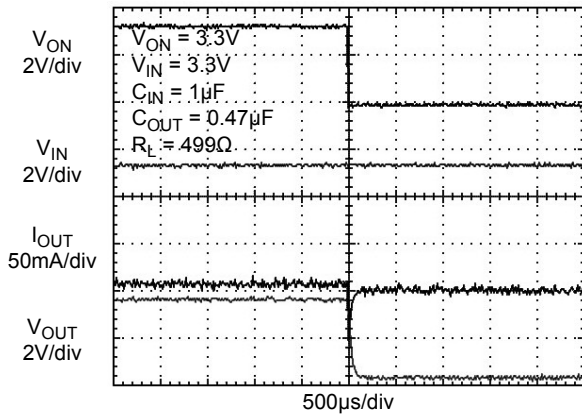

Figure 25. FPF1009 Turn OFF Response
Load current is discharged through On-chip output discharge resistor.

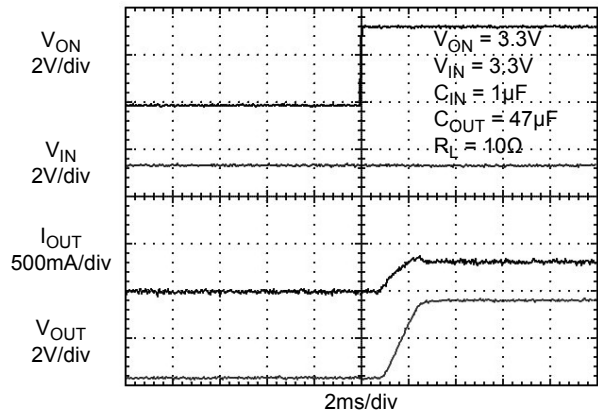

Figure 26. FPF1009 Turn ON Response ($C_{OUT} = 47\mu F$)

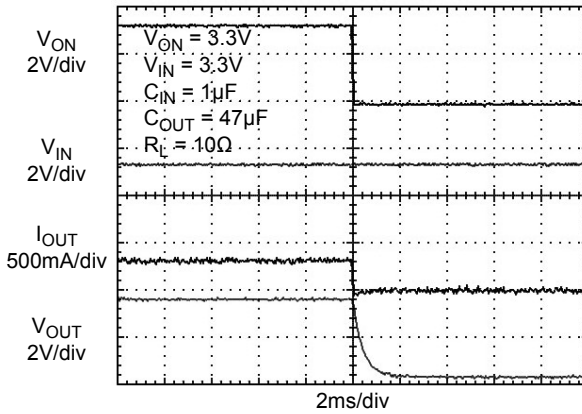

Figure 27. FPF1009 Turn OFF Response

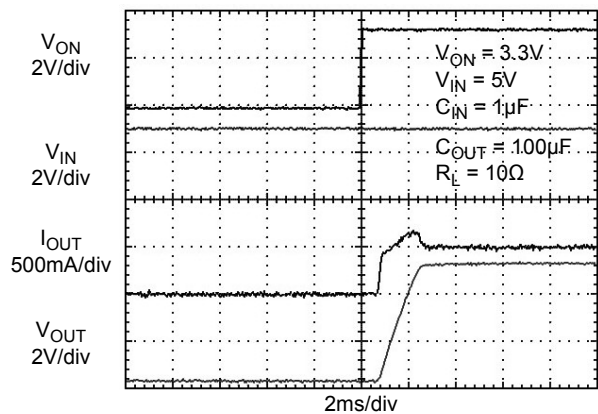
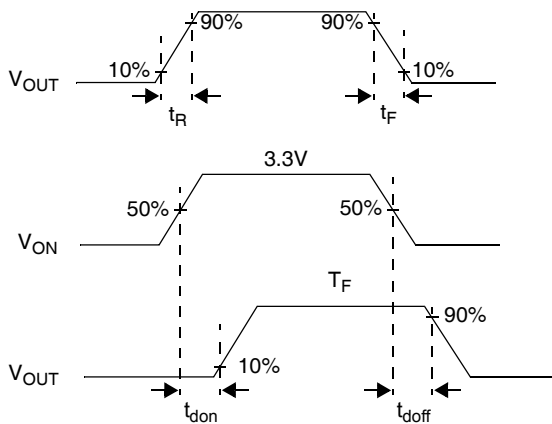

Figure 28. FPF1009 Turn ON Response
($C_{OUT} = 100\mu F$, $V_{IN} = 5V$)

Timing Diagram



where:

- t_{ON} = Turn ON Time
- t_{OFF} = Turn OFF Time
- t_{don} = Turn ON Delay Time
- t_{doff} = Turn OFF Delay Time
- t_R = Rise Time
- t_F = V_{OUT} Fall Time
- $t_{ON} = t_R + t_{don}$
- $t_{OFF} = t_F + t_{doff}$

Dimensional Outline and Pad Layout

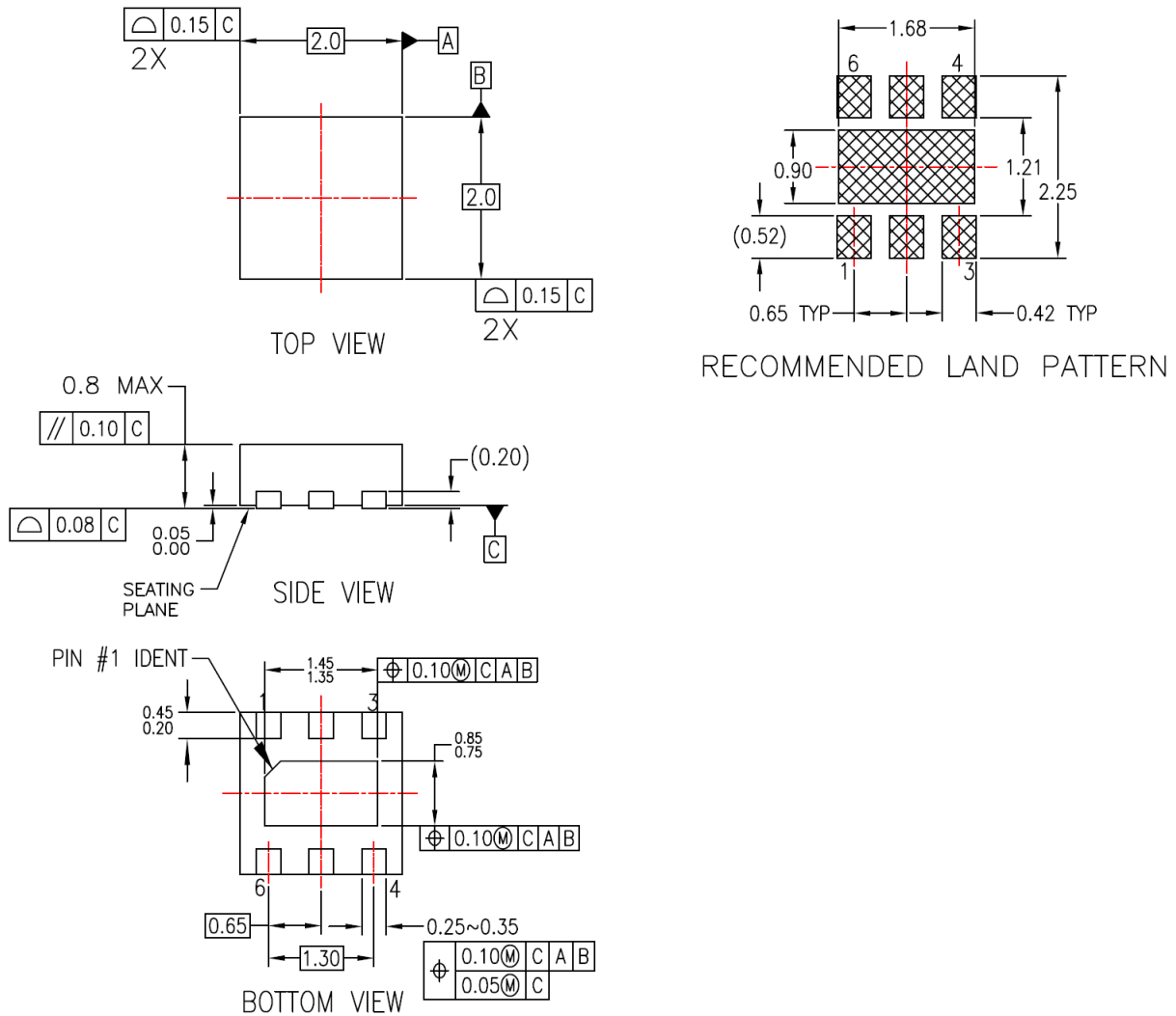

NOTES:

- A. NON-CONFORMS TO JEDEC REGISTRATION,
- B. DIMENSIONS ARE IN MILLIMETERS.
- C. DIMENSIONS AND TOLERANCES PER ASME Y14.5M, 1994

MLP06KrevA



TRADEMARKS

The following are registered and unregistered trademarks and service marks Fairchild Semiconductor owns or is authorized to use and is not intended to be an exhaustive list of all such trademarks.

- | | | | |
|---|-------------------------------------|----------------------------|----------------------|
| ACEx® | FPS™ | PDP-SPM™ | SupreMOS™ |
| Build it Now™ | FRFET® | Power220® | SyncFET™ |
| CorePLUS™ | Global Power Resource SM | POWEREDGE® | SYSTEM ® |
| CROSSVOLT™ | Green FPS™ | Power-SPM™ | GENERAL |
| CTL™ | Green FPS™ e-Series™ | PowerTrench® | The Power Franchise® |
| Current Transfer Logic™ | GTO™ | Programmable Active Droop™ | power |
| EcoSPARK® | i-Lo™ | QFET® | franchise |
| EZSWITCH™ * | IntelliMAX™ | QS™ | TinyBoost™ |
|  ™ | ISOPLANAR™ | QT Optoelectronics™ | TinyBuck™ |
| F ® | MegaBuck™ | Quiet Series™ | TinyLogic® |
| Fairchild® | MICROCOUPLER™ | RapidConfigure™ | TINYOPTO™ |
| Fairchild Semiconductor® | MicroFET™ | SMART START™ | TinyPower™ |
| FACT Quiet Series™ | MicroPak™ | SPM® | TinyPWM™ |
| FACT® | MillerDrive™ | STEALTH™ | TinyWire™ |
| FAST® | Motion-SPM™ | SuperFET™ | µSerDes™ |
| FastvCore™ | OPTOLOGIC® | SuperSOT™-3 | UHC® |
| FlashWriter® * | OPTOPLANAR® | SuperSOT™-6 | Ultra FRFET™ |
| | | SuperSOT™-8 | UniFET™ |
| | | | VCX™ |

* EZSWITCH™ and FlashWriter® are trademarks of System General Corporation, used under license by Fairchild Semiconductor.

DISCLAIMER

FAIRCHILD SEMICONDUCTOR RESERVES THE RIGHT TO MAKE CHANGES WITHOUT NOTICE TO ANY PRODUCTS HEREIN TO IMPROVE RELIABILITY, FUNCTION, OR DESIGN. FAIRCHILD DOES NOT ASSUME ANY LIABILITY ARISING OUT OF THE APPLICATION OR USE OF ANY PRODUCT OR CIRCUIT DESCRIBED HEREIN; NEITHER DOES IT CONVEY ANY LICENSE UNDER ITS PATENT RIGHTS, NOR THE RIGHTS OF OTHERS. THESE SPECIFICATIONS DO NOT EXPAND THE TERMS OF FAIRCHILD'S WORLDWIDE TERMS AND CONDITIONS, SPECIFICALLY THE WARRANTY THEREIN, WHICH COVERS THESE PRODUCTS.

LIFE SUPPORT POLICY

FAIRCHILD'S PRODUCTS ARE NOT AUTHORIZED FOR USE AS CRITICAL COMPONENTS IN LIFE SUPPORT DEVICES OR SYSTEMS WITHOUT THE EXPRESS WRITTEN APPROVAL OF FAIRCHILD SEMICONDUCTOR CORPORATION.

As used herein:

- Life support devices or systems are devices or systems which, (a) are intended for surgical implant into the body, or (b) support or sustain life, and (c) whose failure to perform when properly used in accordance with instructions for use provided in the labeling, can be reasonably expected to result in significant injury to the user.
- A critical component is any component of a life support device or system whose failure to perform can be reasonably expected to cause the failure of the life support device or system, or to affect its safety or effectiveness.

PRODUCT STATUS DEFINITIONS

Definition of Terms

Datasheet Identification	Product Status	Definition
Advance Information	Formative or In Design	This datasheet contains the design specifications for product development. Specifications may change in any manner without notice.
Preliminary	First Production	This datasheet contains preliminary data; supplementary data will be published at a later date. Fairchild Semiconductor reserves the right to make changes at any time without notice to improve design.
No Identification Needed	Full Production	This datasheet contains final specifications. Fairchild Semiconductor reserves the right to make changes at any time without notice to improve design.
Obsolete	Not In Production	This datasheet contains specifications on a product that has been discontinued by Fairchild semiconductor. The datasheet is printed for reference information only.