

FPF1003-FPF1004 IntelliMAX™ Advanced Load Management Products

Features

- 1.2 to 5.5V Input Voltage Range
- $R_{DS(ON)} = 30\text{ m}\Omega @ V_{IN} = 5.5\text{V}$
- $R_{DS(ON)} = 35\text{ m}\Omega @ V_{IN} = 3.3\text{V}$
- ESD Protected, above 2000V HBM

Applications

- PDAs
- Cell Phones
- GPS Devices
- MP3 Players
- Digital Cameras
- Peripheral Ports
- Hot Swap Supplies
- RoHS Compliant

General Description

The FPF1003 & FPF1004 are low RDS P-Channel MOSFET load switches with controlled turn-on. The input voltage range operates from 1.2V to 5.5V to fulfill today's Ultra Portable Device's supply requirement. Switch control is by a logic input (ON) capable of interfacing directly with low voltage control signal. In FPF1004, 120Ω on-chip load resistor is added for output quick discharge when switch is turned off.

Both FPF1003 & FPF1004 are available in a space-saving 1.0x1.5 mm² chip scale package, 1.0X1.5CSP-6.

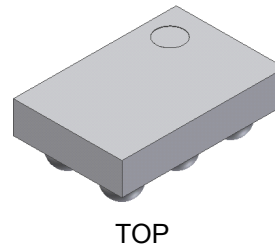
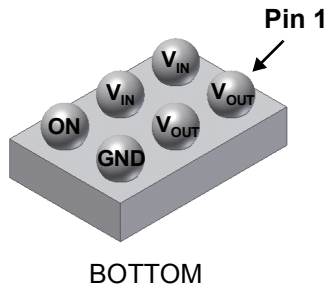

Typical Application Circuit

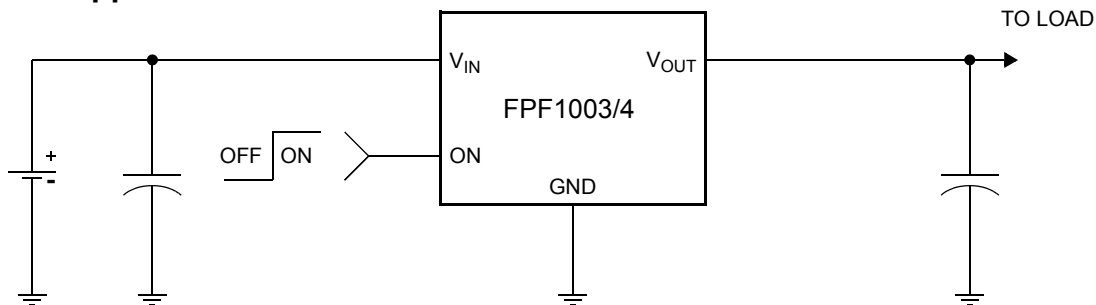

Ordering Information

Part	Switch	Input buffer	Output Discharge	ON Pin Activity	Top Mark
FPF1003	30mΩ, PMOS	Schmitt	NA	Active HI	3
FPF1004	30mΩ, PMOS	Schmitt	120Ω	Active HI	4

Functional Block Diagram

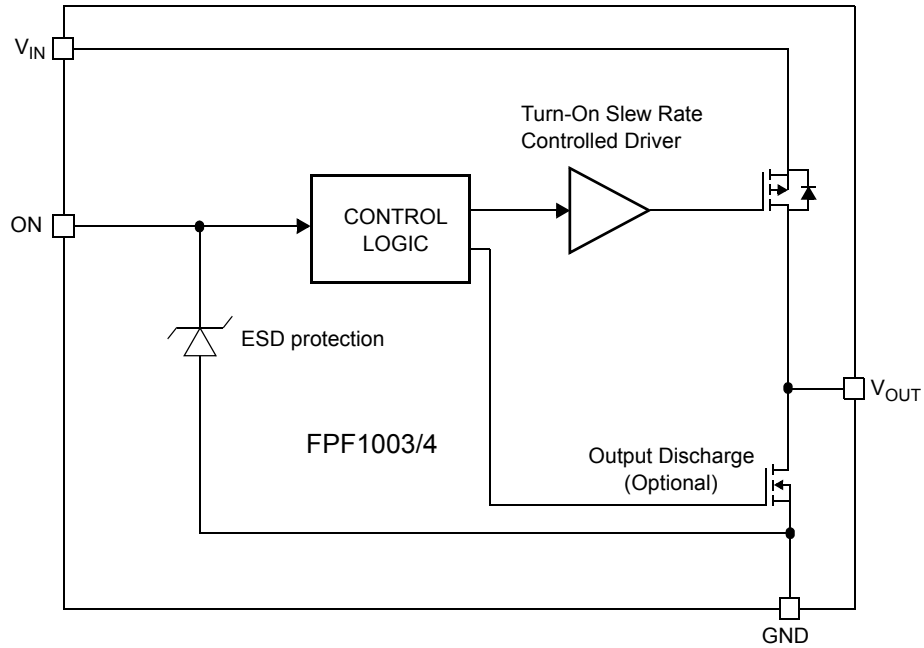

Pin Configuration

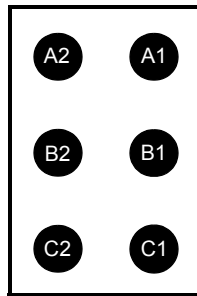

1.0 x 1.5 CSP Bottom View

Pin Description

Pin	Name	Function
A2, B2	V_{IN}	Supply Input: Input to the power switch and the supply voltage for the IC
C2	ON	ON Control Input
A1, B1	V_{OUT}	Switch Output: Output of the power switch
C1	GND	Ground

Absolute Maximum Ratings

Parameter		Min	Max	Unit
V_{IN} , V_{OUT} , ON to GND		-0.3	6	V
Power Dissipation @ $T_A = 25^\circ\text{C}$ (Note 1)			1.2	W
Maximum Continuous Switch Current			2.0	A
Operating Temperature Range		-40	125	$^\circ\text{C}$
Storage Temperature		-65	150	$^\circ\text{C}$
Thermal Resistance, Junction to Ambient			85	$^\circ\text{C/W}$
Electrostatic Discharge Protection	HBM	2000		V
	MM	200		V

Recommended Operating Range

Parameter		Min	Max	Unit
V_{IN}		1.2	5.5	V
Ambient Operating Temperature, T_A		-40	85	$^\circ\text{C}$

Electrical Characteristics

$V_{IN} = 1.2$ to 5.5V , $T_A = -40$ to $+85^\circ\text{C}$ unless otherwise noted. Typical values are at $V_{IN} = 3.3\text{V}$ and $T_A = 25^\circ\text{C}$.

Parameter	Symbol	Conditions	Min	Typ	Max	Units
Basic Operation						
Operating Voltage	V_{IN}		1.2		5.5	V
Quiescent Current	I_Q	$I_{OUT} = 0\text{mA}$, $V_{IN} = V_{ON}$			1	μA
Off Supply Current	$I_{Q(off)}$	$V_{ON} = \text{GND}$, $\text{OUT} = \text{open}$			1	μA
Off Switch Current	$I_{SD(off)}$	$V_{ON} = \text{GND}$, $V_{OUT} = 0$ @ $V_{IN} = 5.5\text{V}$, $T_A = 85^\circ\text{C}$			1	μA
		$V_{ON} = \text{GND}$, $V_{OUT} = 0$ @ $V_{IN} = 3.3\text{V}$, $T_A = 25^\circ\text{C}$		10	100	nA
On-Resistance	R_{ON}	$V_{IN} = 5.5\text{V}$, $T_A = 25^\circ\text{C}$		20	30	m Ω
		$V_{IN} = 3.3\text{V}$, $T_A = 25^\circ\text{C}$		25	35	
		$V_{IN} = 1.5\text{V}$, $T_A = 25^\circ\text{C}$		50	75	
		$V_{IN} = 1.2\text{V}$, $T_A = 25^\circ\text{C}$		95	150	
Output Pull Down Resistance	R_{PD}	$V_{IN} = 3.3\text{V}$, $V_{ON} = 0\text{V}$, $T_A = 25^\circ\text{C}$, FPF1004		75	120	Ω
ON Input Logic High Voltage	V_{IH}	$V_{IN} = 2.7\text{V}$ to 5.5V	2			V
		$V_{IN} = 1.2\text{V}$	0.8			
ON Input Logic Low Voltage	V_{IL}	$V_{IN} = 2.7\text{V}$ to 5.5V			0.8	V
		$V_{IN} = 1.2\text{V}$			0.35	
ON Input Leakage		$V_{ON} = V_{IN}$ or GND			1	μA
Dynamic						
Turn on delay	t_{ON}	$V_{IN} = 3.3\text{V}$, $R_L = 500\Omega$, $C_L = 0.1\mu\text{F}$, $T_A = 25^\circ\text{C}$		13		μs
Turn off delay	t_{OFF}	$V_{IN} = 3.3\text{V}$, $R_L = 500\Omega$, $C_L = 0.1\mu\text{F}$, $T_A = 25^\circ\text{C}$, FPF1003		45		μs
		$V_{IN} = 3.3\text{V}$, $R_L = 500\Omega$, $C_L = 0.1\mu\text{F}$, $R_{L_CHIP} = 120\Omega$, $T_A = 25^\circ\text{C}$, FPF1004		15		μs
V_{OUT} Rise Time	t_R	$V_{IN} = 3.3\text{V}$, $R_L = 500\Omega$, $C_L = 0.1\mu\text{F}$, $T_A = 25^\circ\text{C}$		13		μs
V_{OUT} Fall Time	t_F	$V_{IN} = 3.3\text{V}$, $R_L = 500\Omega$, $C_L = 0.1\mu\text{F}$, $T_A = 25^\circ\text{C}$, FPF1003		113		μs
		$V_{IN} = 3.3\text{V}$, $R_L = 500\Omega$, $C_L = 0.1\mu\text{F}$, $R_{L_CHIP} = 120\Omega$, $T_A = 25^\circ\text{C}$, FPF1004		10		μs

Note 1: Package power dissipation on 1square inch pad, 2 oz. copper board.

Typical Characteristics

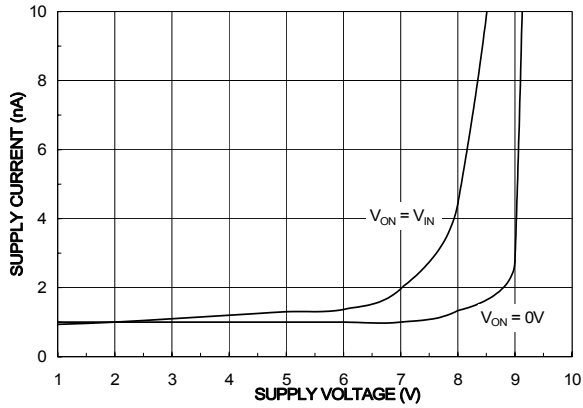

Figure 1. Quiescent Current vs. V_{IN}

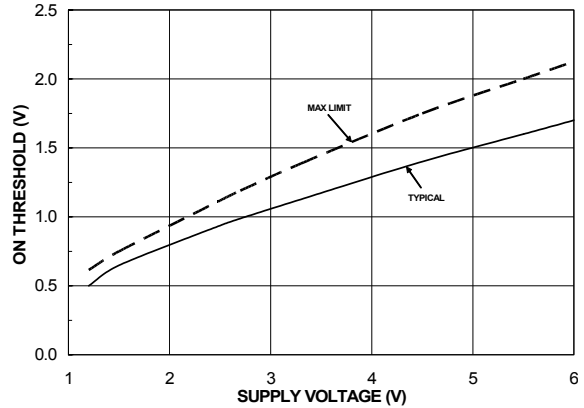

Figure 2. ON Threshold vs. V_{IN}

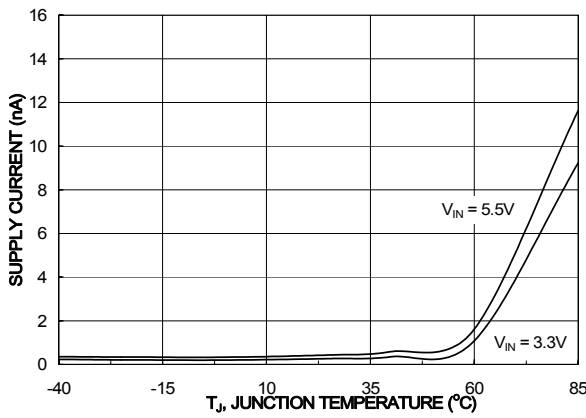

Figure 3. Quiescent Current vs. Temperature

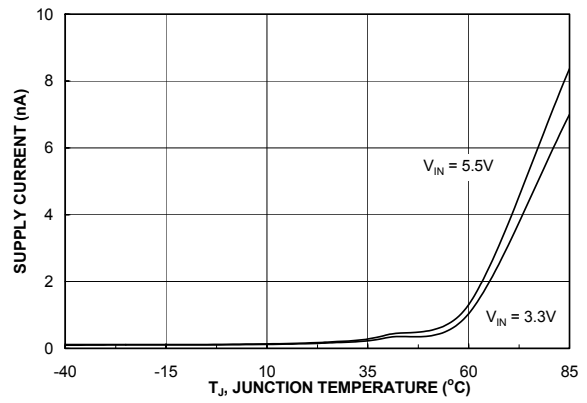

Figure 4. Quiescent Current (off) vs. Temperature

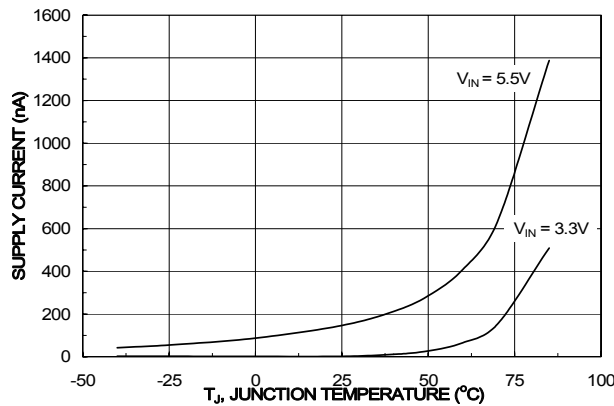

Figure 5. $I_{\text{SWITCH-OFF}}$ Current vs. Temperature

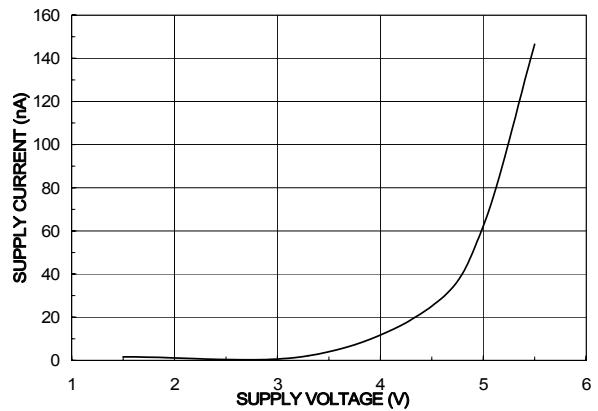

Figure 6. $I_{\text{SWITCH-OFF}}$ Current vs. V_{IN}

Typical Characteristics

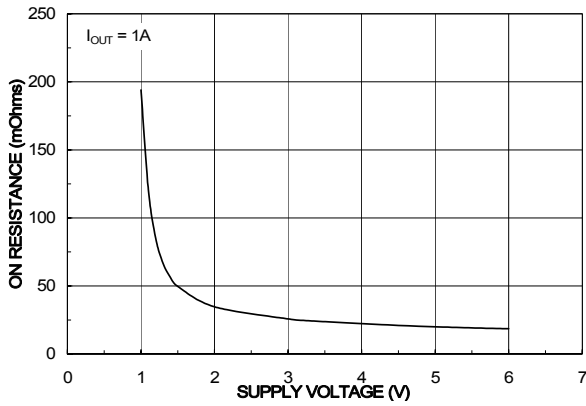

Figure 7. R_{ON} vs. V_{IN}

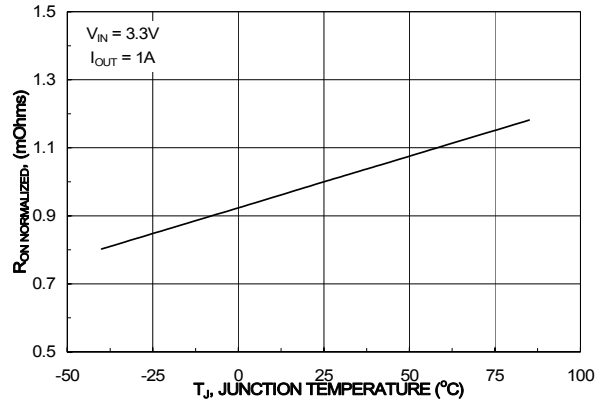

Figure 8. R_{ON} vs. Temperature

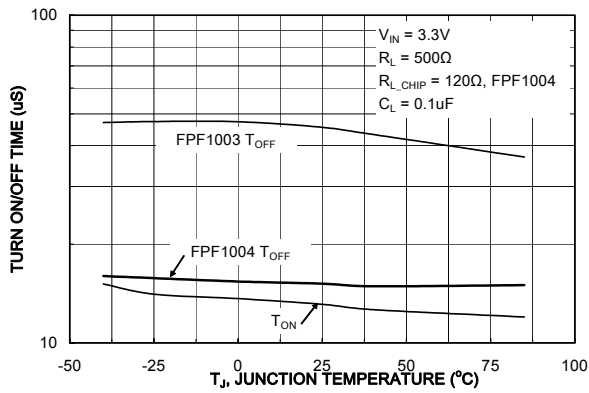

Figure 9. T_{ON}/T_{OFF} vs. Temperature

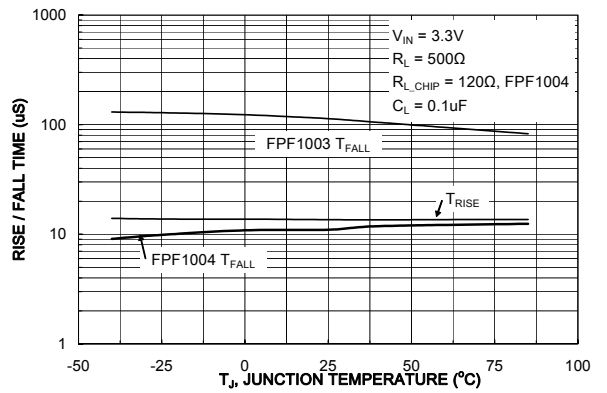

Figure 10. T_{RISE}/T_{FALL} vs. Temperature

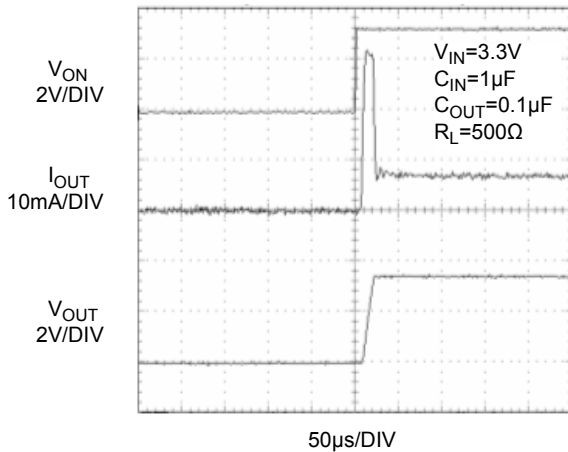

Figure 11. FPF1003 T_{ON} Response

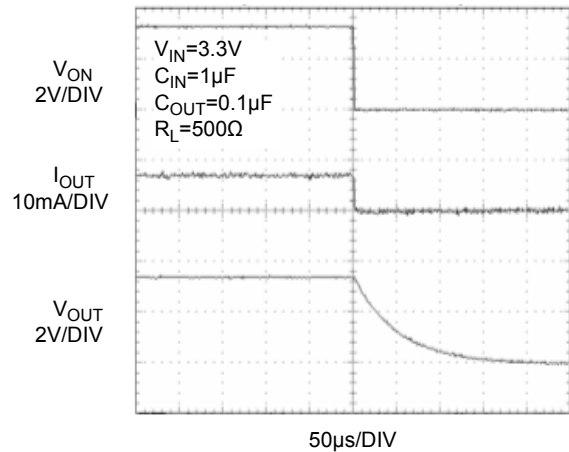

Figure 12. FPF1003 T_{OFF} Response

Typical Characteristics

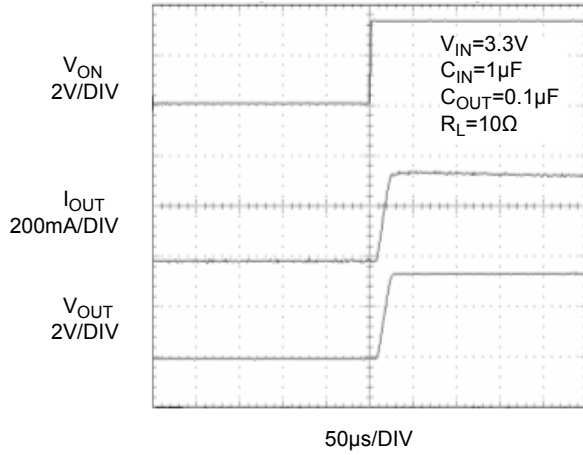

Figure 13. FPF1003 T_{ON} Response

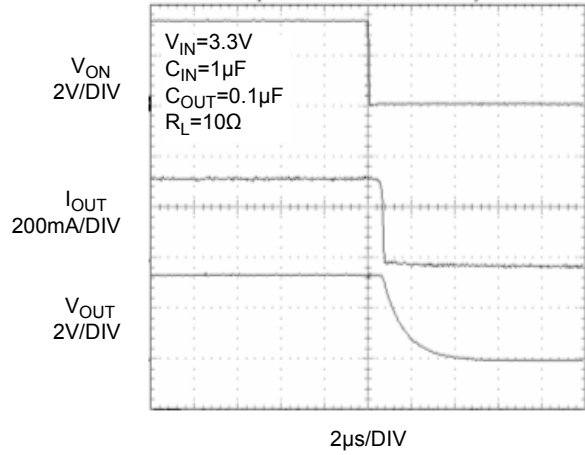

Figure 14. FPF1003 T_{OFF} Response

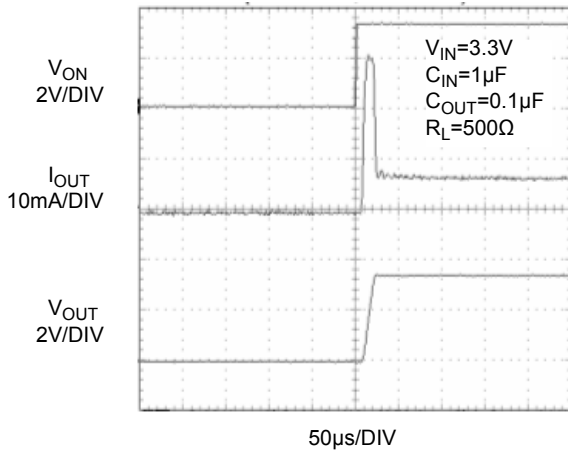

Figure 15. FPF1004 T_{ON} Response

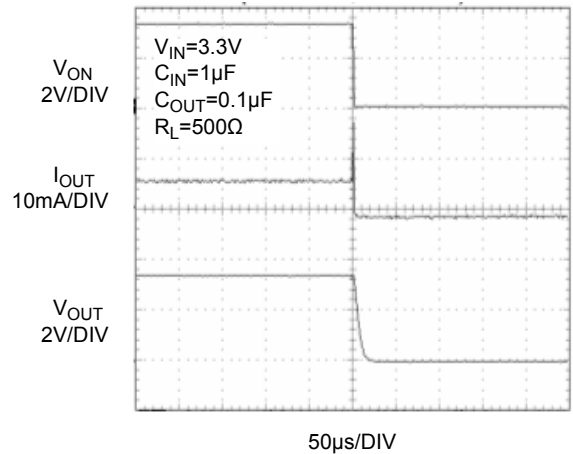

Figure 16. FPF1004 T_{OFF} Response

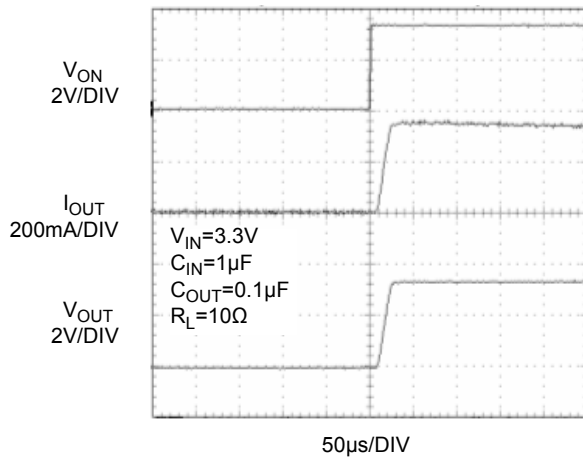

Figure 17. FPF1004 T_{ON} Response

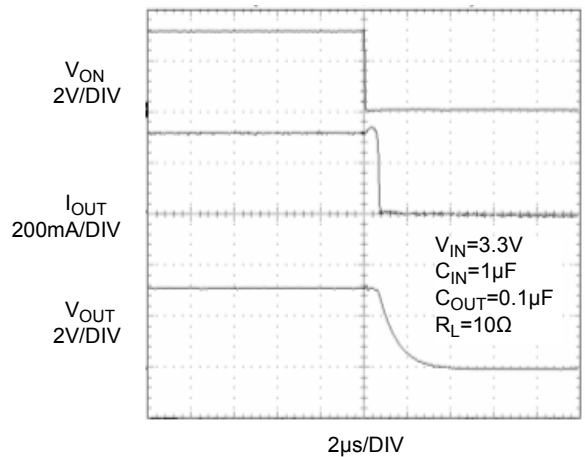

Figure 18. FPF1004 T_{OFF} Response

Description of Operation

The FPF1003 & FPF1004 are low $R_{DS(ON)}$ P-Channel load switches with controlled turn-on. The core of each device is a 30mΩ P-Channel MOSFET and a controller capable of functioning over a wide input operating range of 1.2-5.5V. Switch control is by a logic input (ON) capable of interfacing directly with low voltage control signal. In FPF1004, 120Ω on-chip load resistor is added for output quick discharge when switch is turned off.

Application Information

Typical Application

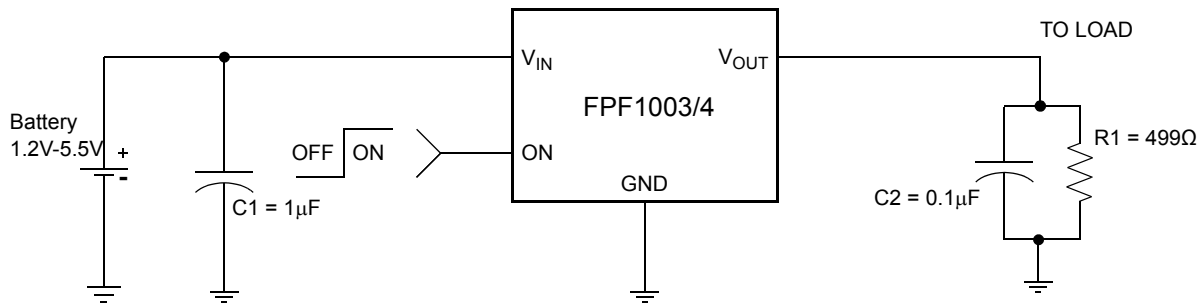

Input Capacitor

To limit the voltage drop on the input supply caused by transient in-rush currents when the switch turns-on into a discharged load capacitor or short-circuit, a capacitor needs to be placed between V_{IN} and GND. A 1µF ceramic capacitor, C_{IN} , placed close to the pins is usually sufficient. Higher values of C_{IN} can be used to further reduce the voltage drop.

Board Layout

For best performance, all traces should be as short as possible. To be most effective, the input and output capacitors should be placed close to the device to minimize the effects that parasitic trace inductances may have on normal and short-circuit operation. Using wide traces for V_{IN} , V_{OUT} and GND will help minimize the parasitic electrical effects along with minimizing the case to ambient thermal impedance.

Output Capacitor

A 0.1µF capacitor, C_{OUT} , should be placed between V_{OUT} and GND. This capacitor will prevent parasitic board inductance from forcing V_{OUT} below GND when the switch turns-off. Due to the integral body diode in the PMOS switch, a C_{IN} greater than C_{OUT} is highly recommended. A C_{OUT} greater than C_{IN} can cause V_{OUT} to exceed V_{IN} when the system supply is removed. This could result in current flow through the body diode from V_{OUT} to V_{IN} .

Dimensional Outline and Pad Layout

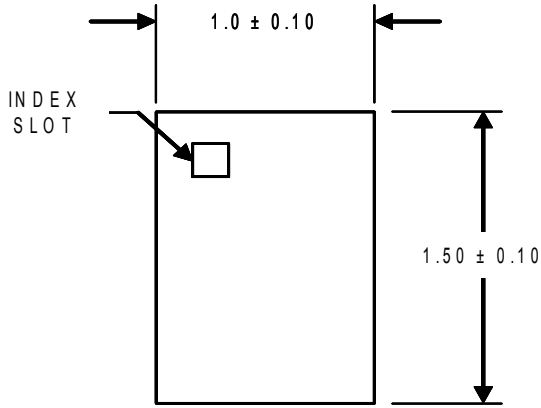

TOP VIEW

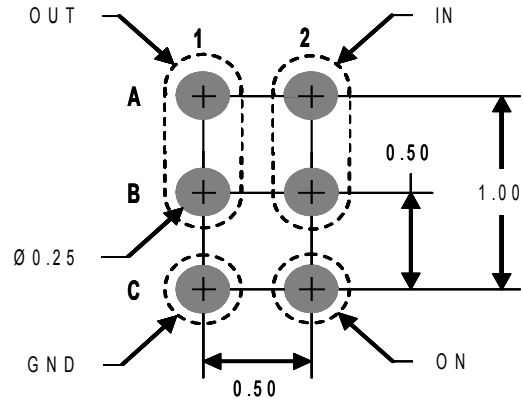

RECOMMENDED LAND PATTERN

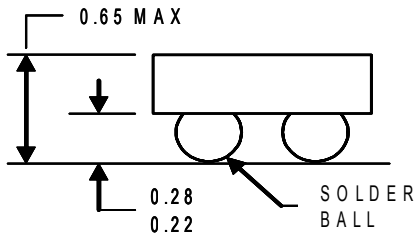

SIDE VIEW

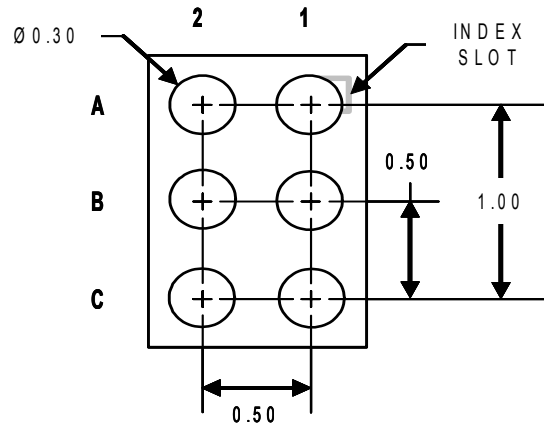

BOTTOM VIEW

NOTES:

A) ALL DIMENSIONS ARE IN MILLIMETERS.



TRADEMARKS

The following are registered and unregistered trademarks Fairchild Semiconductor owns or is authorized to use and is not intended to be an exhaustive list of all such trademarks.

ACEx [®]	GTO [™]	Power247 [®]	SyncFET [™]
Across the board. Around the world.™	HiSeC [™]	PowerEdge [™]	TCM [™]
ActiveArray [™]	<i>i-Lo</i> [™]	PowerSaver [™]	The Power Franchise [®]
Bottomless [™]	ImpliedDisconnect [™]	Power-SPM [™]	 ™
Build it Now [™]	IntelliMAX [™]	PowerTrench [®]	TinyBoost [™]
CoolFET [™]	ISOPLANAR [™]	Programmable Active Droop [™]	TinyBuck [™]
CROSSVOLT [™]	MICROCOUPLER [™]	QFET [®]	TinyLogic [®]
CTL [™]	MicroPak [™]	QS [™]	TINYOPTO [™]
Current Transfer Logic [™]	MICROWIRE [™]	QT Optoelectronics [™]	TinyPower [™]
DOME [™]	Motion-SPM [™]	Quiet Series [™]	TinyWire [™]
E ² CMOS [™]	MSX [™]	RapidConfigure [™]	TruTranslation [™]
EcoSPARK [®]	MSXPro [™]	RapidConnect [™]	µSerDes [™]
EnSigna [™]	OCX [™]	ScalarPump [™]	UHC [®]
FACT Quiet Series [™]	OCXPro [™]	SMART START [™]	UniFET [™]
FACT [®]	OPTOLOGIC [®]	SPM [®]	VCX [™]
FAST [®]	OPTOPLANAR [®]	STEALTH [™]	Wire [™]
FASTr [™]	PACMAN [™]	SuperFET [™]	
FPS [™]	PDP-SPM [™]	SuperSOT [™] -3	
FRFET [®]	POP [™]	SuperSOT [™] -6	
GlobalOptoisolator [™]	Power220 [®]	SuperSOT [™] -8	

DISCLAIMER

FAIRCHILD SEMICONDUCTOR RESERVES THE RIGHT TO MAKE CHANGES WITHOUT FURTHER NOTICE TO ANY PRODUCTS HEREIN TO IMPROVE RELIABILITY, FUNCTION, OR DESIGN. FAIRCHILD DOES NOT ASSUME ANY LIABILITY ARISING OUT OF THE APPLICATION OR USE OF ANY PRODUCT OR CIRCUIT DESCRIBED HEREIN; NEITHER DOES IT CONVEY ANY LICENSE UNDER ITS PATENT RIGHTS, NOR THE RIGHTS OF OTHERS. THESE SPECIFICATIONS DO NOT EXPAND THE TERMS OF FAIRCHILD'S WORLDWIDE TERMS AND CONDITIONS, SPECIFICALLY THE WARRANTY THEREIN, WHICH COVERS THESE PRODUCTS.

LIFE SUPPORT POLICY

FAIRCHILD'S PRODUCTS ARE NOT AUTHORIZED FOR USE AS CRITICAL COMPONENTS IN LIFE SUPPORT DEVICES OR SYSTEMS WITHOUT THE EXPRESS WRITTEN APPROVAL OF FAIRCHILD SEMICONDUCTOR CORPORATION.

As used herein:

1. Life support devices or systems are devices or systems which, (a) are intended for surgical implant into the body, or (b) support or sustain life, and (c) whose failure to perform when properly used in accordance with instructions for use provided in the labeling, can be reasonably expected to result in significant injury to the user.
2. A critical component is any component of a life support device or system whose failure to perform can be reasonably expected to cause the failure of the life support device or system, or to affect its safety or effectiveness.

PRODUCT STATUS DEFINITIONS

Definition of Terms

Datasheet Identification	Product Status	Definition
Advance Information	Formative or In Design	This datasheet contains the design specifications for product development. Specifications may change in any manner without notice.
Preliminary	First Production	This datasheet contains preliminary data; supplementary data will be published at a later date. Fairchild Semiconductor reserves the right to make changes at any time without notice to improve design.
No Identification Needed	Full Production	This datasheet contains final specifications. Fairchild Semiconductor reserves the right to make changes at any time without notice to improve design.
Obsolete	Not In Production	This datasheet contains specifications on a product that has been discontinued by Fairchild semiconductor. The datasheet is printed for reference information only.

Rev. I26