

FKN08PN60S

TRIAC (Silicon Bidirectional Thyristor)

Application Explanation

- Switching mode power supply, light dimmer, electric flasher unit, hair drier
- TV sets, stereo, refrigerator, washing machine
- Electric blanket, solenoid driver, small motor control
- Photo copier, electric tool

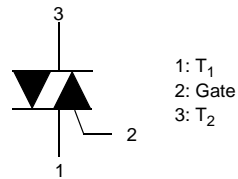
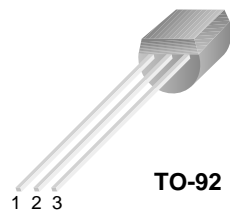

Absolute Maximum Ratings T_a = 25°C unless otherwise noted

Symbol	Parameter	Value	Rating	Units
V _{DRM} V _{RRM}	Peak Repetitive Off-State Voltage	Sine Wave 50 to 60Hz, Gate Open	600	V
I _{T (RMS)}	RMS On-State Current	Commercial frequency, sine full wave 360° conduction, T _c = 70 °C	0.8	A
I _{TSM}	Surge On-State Current	Sinewave half cycle, peak value, non-repetitive	60Hz 8	A
I ² t	I ² t for Fusing	Value corresponding to halfwave, surge on-state current, tp=8.33ms	0.26	A ² s
P _{GM}	Peak Gate Power Dissipation		5	W
P _{G (AV)}	Average Gate Power Dissipation		0.1	W
V _{GM}	Peak Gate Voltage		5	V
I _{GM}	Peak Gate Current		1	A
T _J	Junction Temperature		- 40 ~ 125	°C
T _{STG}	Storage Temperature		- 40 ~ 125	°C

Thermal Characteristics

Symbol	Parameter	Value	Units
R _{θJC}	Thermal Resistance, Junction to Case ^(note1)	45	°C/W
R _{θJA}	Thermal Resistance, Junction to Ambient ^(note2)	160	°C/W

Note1: Infinite cooling condition.

Note2: JESD51-10 (Test Borad: FR4 3.0"*4.5"*0.062", Minimum land pad)

Electrical Characteristics T_C = 25°C unless otherwise noted

Symbol	Parameter	Test Condition	Min.	Typ.	Max.	Units	
I _{DRM} I _{RRM}	Repetitive Peak Off-State Current	V _{DRM} /V _{RRM} applied	-	-	100	μA	
V _{TM}	On-State Voltage	T _C =25°C, I _{TM} =1.12A Instantaneous measurement	-	-	1.8	V	
V _{GT}	Gate Trigger Voltage (Note 2)	V _D =12V, R _L =100Ω	T2(+), Gate (+)	-	-	2.0	V
			T2(+), Gate (-)	-	-	2.0	V
			T2(-), Gate (-)	-	-	2.0	V
I _{GT}	Gate Trigger Current (Note 2)	V _D =12V, R _L =100Ω	T2(+), Gate (+)	-	-	5	mA
			T2(+), Gate (-)	-	-	5	mA
			T2(-), Gate (-)	-	-	5	mA
V _{GD}	Gate Non-Trigger Voltage	T _J =125°C, V _D =1/2V _{DRM}	0.2	-	-	V	
I _H	Holding Current (I, II, III)	V _D = 12V, I _{TM} = 200mA	-	-	15	mA	
I _L	Latching Current	V _D = 12V, I _G = 10mA	I, III	-	-	15	mA
			II	-	-	20	mA
dv/dt(s)	Critical Rate of Rise of Off-State Voltage	V _{DRM} = 63% Rated, T _J = 125°C, Exponential Rise	20	-	-	V/μs	
dv/dt(c)	Critical-Rate of Rise of Off-State Commutating Voltage (di/dt=-0.7A/uS)		3.0	-	-	V/μs	

Commutation dv/dt test

V _{DRM} (V)	Test Condition	Commutating voltage and current waveforms (inductive load)
FKN08PN60S	<ol style="list-style-type: none"> Junction Temperature T_J=125°C Rate of decay of on-state commutating current (di/dt)_C Peak off-state voltage V_D = 300V 	<p>The diagram shows three waveforms over time: <ul style="list-style-type: none"> Supply Voltage: A sinusoidal wave. Main Current: A sinusoidal wave that decays to zero during the commutation period. The rate of decay is labeled (di/dt)_C. Main Voltage: A square wave that rises to a peak V_D during the commutation period. The rate of rise is labeled (dv/dt)_C. </p>

Quadrant Definitions for a Triac

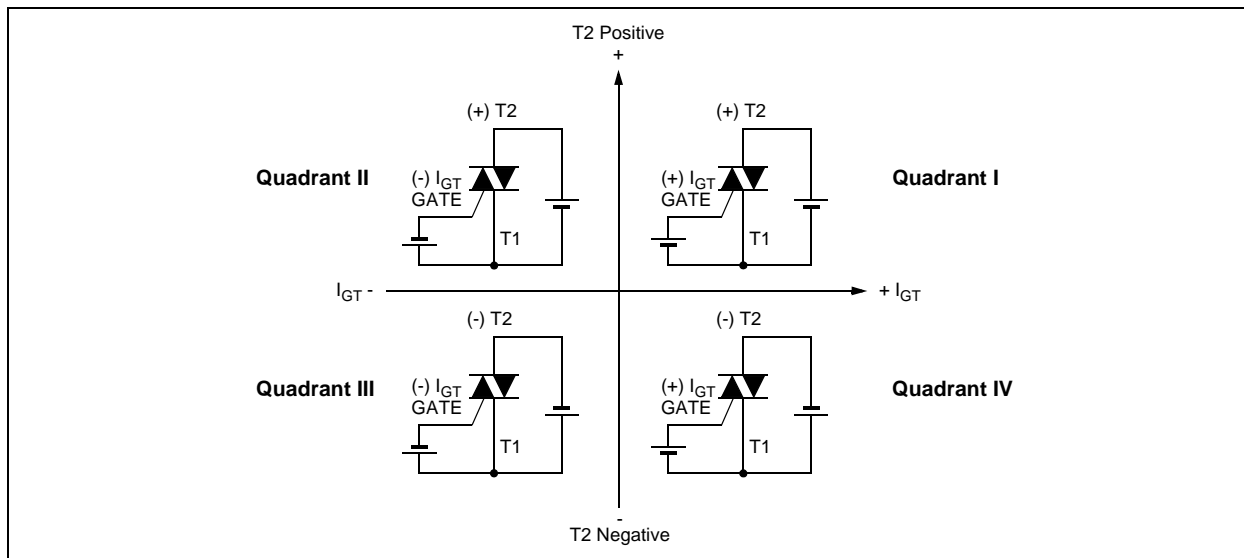

Package Marking and Ordering Information

Device Marking	Device	Package	Packing	Tape Width	Quantity
K08PN60S	FKN08PN60S	TO-92	BULK	--	--

Typical Performance Characteristics

Figure 1. On-State Characteristics

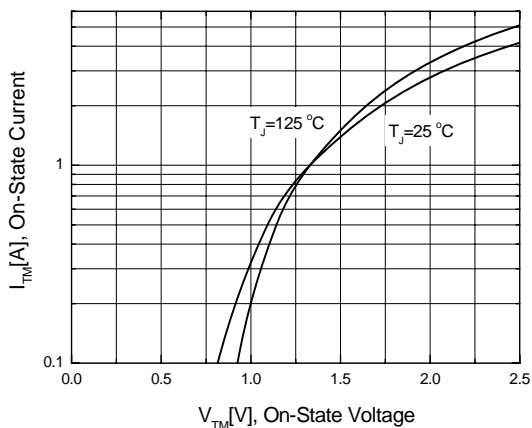

Figure 2. Power Dissipation

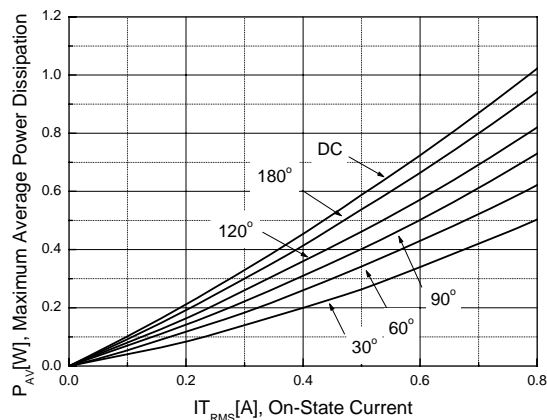

Figure 3. RMS Current Rating

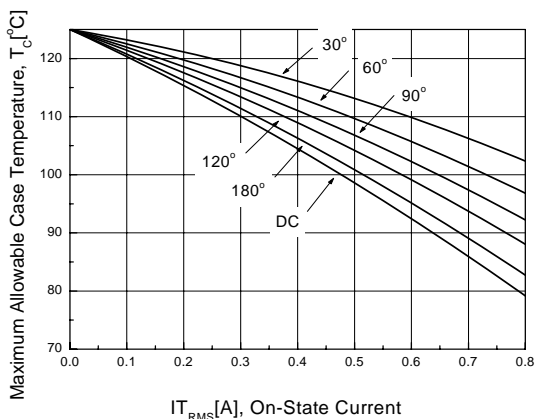

Figure 4. Typical Gate Trigger Current vs Junction Temperature

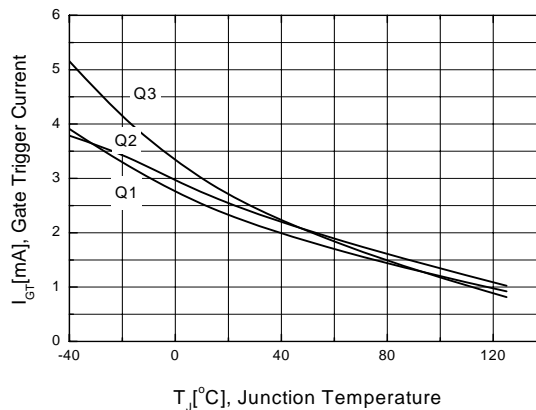

Figure 5. Typical Gate Voltage vs Junction Temperature

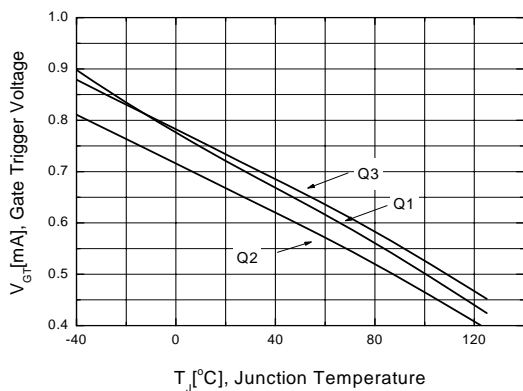
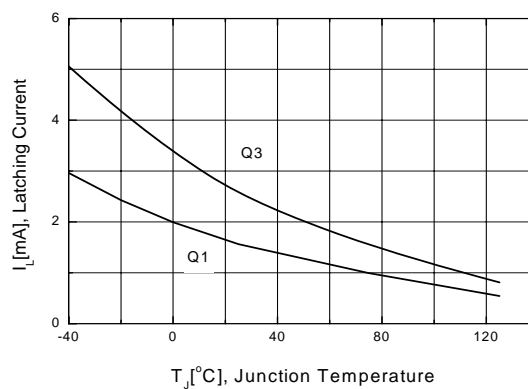

Figure 6. Typical Latching Current vs Junction Temperature



Typical Performance Characteristics (Continued)

Figure7. Typical Holding Current vs Junction Temperature

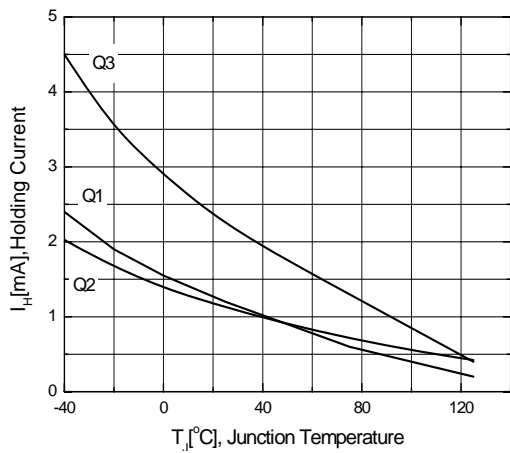
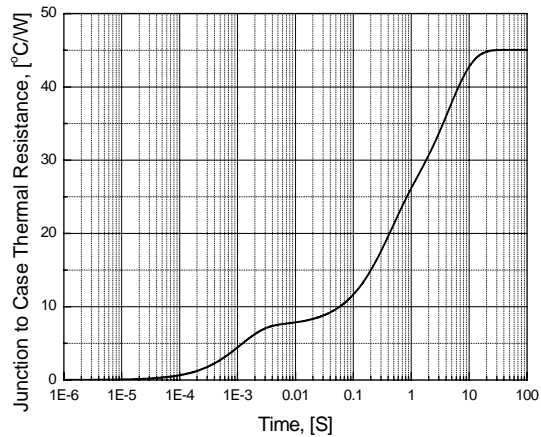
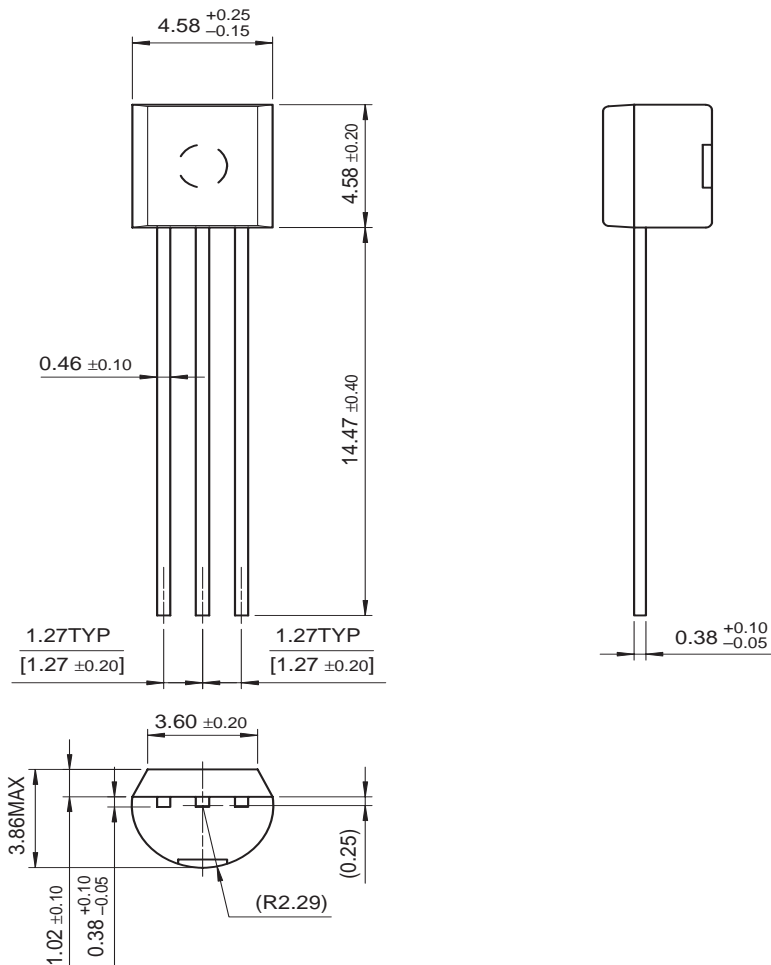

Figure8. Junction to Case Thermal Resistance



Package Dimension

TO-92





TRADEMARKS

The following are registered and unregistered trademarks and service marks Fairchild Semiconductor owns or is authorized to use and is not intended to be an exhaustive list of all such trademarks.

- | | | | |
|--------------------------|----------------------|----------------------------|----------------------|
| ACEx® | Green FPS™ | Power247® | SuperSOT™-8 |
| Build it Now™ | Green FPS™ e-Series™ | POWEREDGE® | SyncFET™ |
| CorePLUSTM | GTO™ | Power-SPM™ | The Power Franchise® |
| CROSSVOLT™ | i-Lo™ | PowerTrench® | the power franchise |
| CTL™ | IntelliMAX™ | Programmable Active Droop™ | QFET™ |
| Current Transfer Logic™ | ISOPLANAR™ | QS™ | TinyBoost™ |
| EcoSPARK® | MegaBuck™ | QT Optoelectronics™ | TinyBuck™ |
| F ® | MICROCOUPLER™ | Quiet Series™ | TinyLogic® |
| Fairchild® | MicroFET™ | RapidConfigure™ | TINYOPTO™ |
| Fairchild Semiconductor® | MicroPak™ | SMART START™ | TinyPower™ |
| FACT Quiet Series™ | MillerDrive™ | SPM® | TinyPWM™ |
| FACT® | Motion-SPM™ | STEALTH™ | TinyWire™ |
| FAST® | OPTOLOGIC® | SuperFET™ | µSerDes™ |
| FastvCore™ | OPTOPLANAR® | SuperSOT™-3 | UHC® |
| FPS™ | ® | SuperSOT™-6 | UniFET™ |
| FRFET® | PDP-SPM™ | | VCX™ |
| Global Power ResourceSM | Power220® | | |

DISCLAIMER

FAIRCHILD SEMICONDUCTOR RESERVES THE RIGHT TO MAKE CHANGES WITHOUT FURTHER NOTICE TO ANY PRODUCTS HEREIN TO IMPROVE RELIABILITY, FUNCTION, OR DESIGN. FAIRCHILD DOES NOT ASSUME ANY LIABILITY ARISING OUT OF THE APPLICATION OR USE OF ANY PRODUCT OR CIRCUIT DESCRIBED HEREIN; NEITHER DOES IT CONVEY ANY LICENSE UNDER ITS PATENT RIGHTS, NOR THE RIGHTS OF OTHERS. THESE SPECIFICATIONS DO NOT EXPAND THE TERMS OF FAIRCHILD'S WORLDWIDE TERMS AND CONDITIONS, SPECIFICALLY THE WARRANTY THEREIN, WHICH COVERS THESE PRODUCTS.

LIFE SUPPORT POLICY

FAIRCHILD'S PRODUCTS ARE NOT AUTHORIZED FOR USE AS CRITICAL COMPONENTS IN LIFE SUPPORT DEVICES OR SYSTEMS WITHOUT THE EXPRESS WRITTEN APPROVAL OF FAIRCHILD SEMICONDUCTOR CORPORATION.

As used herein:

1. Life support devices or systems are devices or systems which, (a) are intended for surgical implant into the body, or (b) support or sustain life, and (c) whose failure to perform when properly used in accordance with instructions for use provided in the labeling, can be reasonably expected to result in significant injury to the user.
2. A critical component is any component of a life support device or system whose failure to perform can be reasonably expected to cause the failure of the life support device or system, or to affect its safety or effectiveness.

PRODUCT STATUS DEFINITIONS

Definition of Terms

Datasheet Identification	Product Status	Definition
Advance Information	Formative or In Design	This datasheet contains the design specifications for product development. Specifications may change in any manner without notice.
Preliminary	First Production	This datasheet contains preliminary data; supplementary data will be published at a later date. Fairchild Semiconductor reserves the right to make changes at any time without notice to improve design.
No Identification Needed	Full Production	This datasheet contains final specifications. Fairchild Semiconductor reserves the right to make changes at any time without notice to improve design.
Obsolete	Not In Production	This datasheet contains specifications on a product that has been discontinued by Fairchild semiconductor. The datasheet is printed for reference information only.