

FDZ4670

N-Channel PowerTrench® MOSFET BGA

30V, 25A, 2.5mΩ

Features

- Max $r_{DS(on)}$ = 2.5mΩ at $V_{GS} = 10V$, $I_D = 25A$
- Max $r_{DS(on)}$ = 4.5mΩ at $V_{GS} = 4.5V$, $I_D = 18.5A$
- Ultra-thin package: less than 0.85mm height when mounted to PCB
- Outstanding thermal transfer characteristics
- Ultra-low gate charge x $r_{DS(on)}$ product
- RoHS Compliant



General Description

Combining Fairchild's 30V PowerTrench process with state-of-the-art BGA packaging, the FDZ4670 minimize both PCB space and $r_{DS(on)}$. This BGA MOSFET embodies a breakthrough in packaging technology which enables the device to combine excellent thermal transfer characteristics, high current handling capacity, ultra-low profile packaging, low gate charge and low $r_{DS(on)}$.

This MOSFET feature faster switching and lower gate charge than other MOSFETs with comparable $r_{DS(on)}$ specifications resulting in DC/DC power supply designs and POL converters with higher overall efficiency.

Applications

- DC - DC Conversion
- POL converters

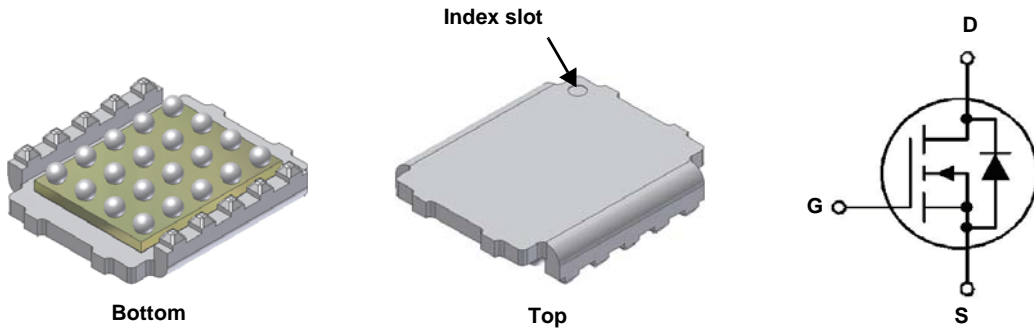

FLFBGA 3.5X4.0

MOSFET Maximum Ratings $T_A = 25^\circ\text{C}$ unless otherwise noted

Symbol	Parameter	Rated	Units
V_{DS}	Drain to Source Voltage	30	V
V_{GS}	Gate to Source Voltage	± 20	V
I_D	Drain Current -Continuous (Note 1a)	25	A
	-Pulsed	60	
P_D	Power Dissipation (Note 1a)	2.5	W
	Power Dissipation (Note 1b)	1.25	
T_J, T_{STG}	Operating and Storage Junction Temperature Range	-55 to +150	$^\circ\text{C}$

Thermal Characteristics

$R_{\theta JA}$	Thermal Resistance, Junction to Ambient (Note 1a)	50	$^\circ\text{C/W}$
$R_{\theta JA}$	Thermal Resistance, Junction to Ambient (Note 1b)	100	
$R_{\theta JC}$	Thermal Resistance, Junction to Case	0.85	

Package Marking and Ordering Information

Device Marking	Device	Package	Reel Size	Tape Width	Quantity
4670	FDZ4670	FLFBGA 3.5X4.0	13"	12mm	3000 units

Electrical Characteristics $T_J = 25^\circ\text{C}$ unless otherwise noted

Symbol	Parameter	Test Conditions	Min	Typ	Max	Units
--------	-----------	-----------------	-----	-----	-----	-------

Off Characteristics

BV_{DSS}	Drain to Source Breakdown Voltage	$I_D = 250\mu\text{A}, V_{GS} = 0\text{V}$	30			V
$\frac{\Delta BV_{DSS}}{\Delta T_J}$	Breakdown Voltage Temperature Coefficient	$I_D = 250\mu\text{A}$, referenced to 25°C		-30		mV/ $^\circ\text{C}$
I_{DSS}	Zero Gate Voltage Drain Current	$V_{DS} = 24\text{V}, V_{GS} = 0\text{V}$			1	μA
I_{GSS}	Gate to Source Leakage Current	$V_{GS} = \pm 20\text{V}, V_{DS} = 0\text{V}$			± 100	nA

On Characteristics

$V_{GS(th)}$	Gate to Source Threshold Voltage	$V_{GS} = V_{DS}, I_D = 250\mu\text{A}$	1	1.7	3	V
$\frac{\Delta V_{GS(th)}}{\Delta T_J}$	Gate to Source Threshold Voltage Temperature Coefficient	$I_D = 250\mu\text{A}$, referenced to 25°C		4.4		mV/ $^\circ\text{C}$
$r_{DS(on)}$	Static Drain to Source On Resistance	$V_{GS} = 10\text{V}, I_D = 25\text{A}$		1.9	2.5	m Ω
		$V_{GS} = 4.5\text{V}, I_D = 18.5\text{A}$		3.0	4.5	
		$V_{GS} = 10\text{V}, I_D = 25\text{A}, T_J = 125^\circ\text{C}$		2.6	3.8	
g_{FS}	Forward Transconductance	$V_{DD} = 10\text{V}, I_D = 25\text{A}$		114		S

Dynamic Characteristics

C_{iss}	Input Capacitance	$V_{DS} = 15\text{V}, V_{GS} = 0\text{V},$ $f = 1\text{MHz}$		2660	3540	pF
C_{oss}	Output Capacitance			1440	1920	pF
C_{rss}	Reverse Transfer Capacitance			180	270	pF
R_g	Gate Resistance	$f = 1\text{MHz}$		1.0		Ω

Switching Characteristics

$t_{d(on)}$	Turn-On Delay Time	$V_{DD} = 15\text{V}, I_D = 1.0\text{A},$ $V_{GS} = 10\text{V}, R_{GEN} = 6\Omega$		15	27	ns
t_r	Rise Time			11	20	ns
$t_{d(off)}$	Turn-Off Delay Time			50	80	ns
t_f	Fall Time			67	107	ns
Q_g	Total Gate Charge	$V_{GS} = 10\text{V}, V_{DD} = 15\text{V},$ $I_D = 25\text{A}$		40	56	nC
Q_{gs}	Gate to Source Charge			7		nC
Q_{gd}	Gate to Drain "Miller" Charge			6		nC

Drain-Source Diode Characteristics

V_{SD}	Source to Drain Diode Forward Voltage	$V_{GS} = 0\text{V}, I_S = 1.8\text{A}$ (Note 2)		0.7	1.2	V
t_{rr}	Reverse Recovery Time	$I_F = 25\text{A}, di/dt = 100\text{A}/\mu\text{s}$		46	69	ns
Q_{rr}	Reverse Recovery Charge			28	42	nC

NOTES:

1. $R_{\theta JA}$ is determined with the device mounted on a 1in² pad 2 oz copper pad on a 1.5 x 1.5 in. board of FR-4 material. $R_{\theta JC}$ is guaranteed by design while $R_{\theta Jc}$ is determined by the user's board design.



a. 50°C/W when mounted on a 1 in² pad of 2 oz copper.



b. 100°C/W when mounted on a minimum pad of 2 oz copper.

2. Pulse Test: Pulse Width < 300 μs , Duty cycle < 2.0%.

Typical Characteristics $T_J = 25^\circ\text{C}$ unless otherwise noted

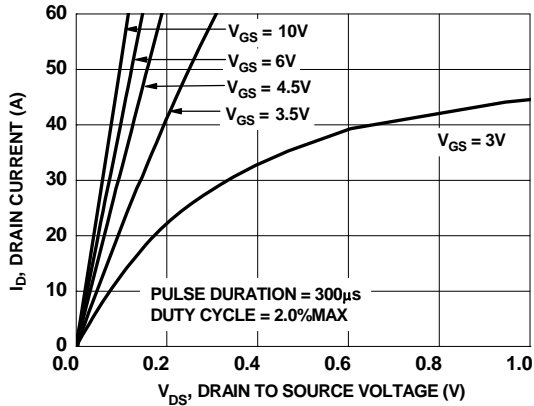

Figure 1. On-Region Characteristics

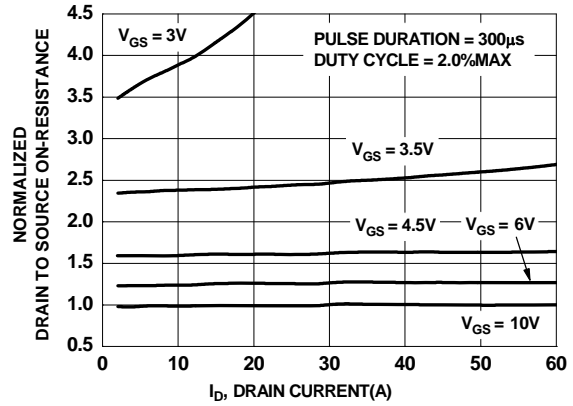

Figure 2. Normalized On-Resistance vs Drain Current and Gate Voltage

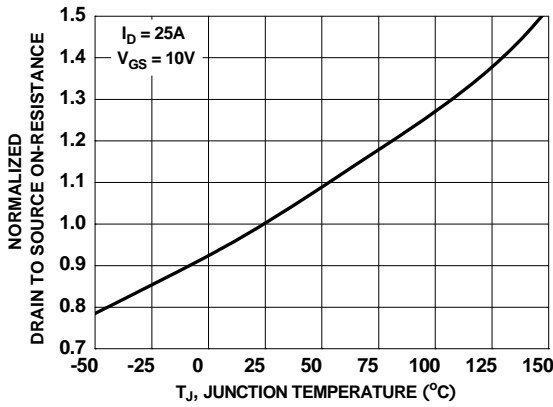

Figure 3. Normalized On-Resistance vs Junction Temperature

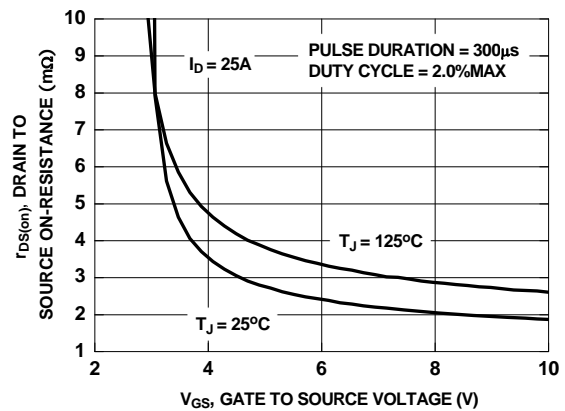

Figure 4. On-Resistance vs Gate to Source Voltage

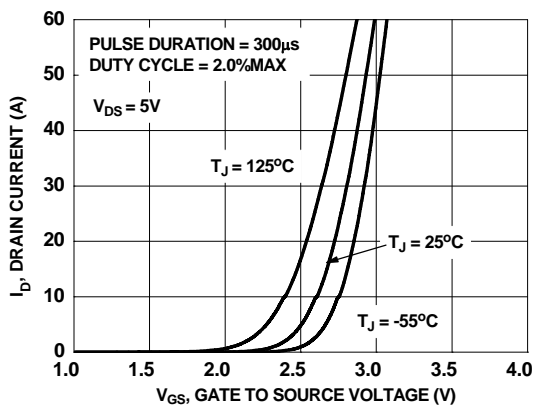

Figure 5. Transfer Characteristics

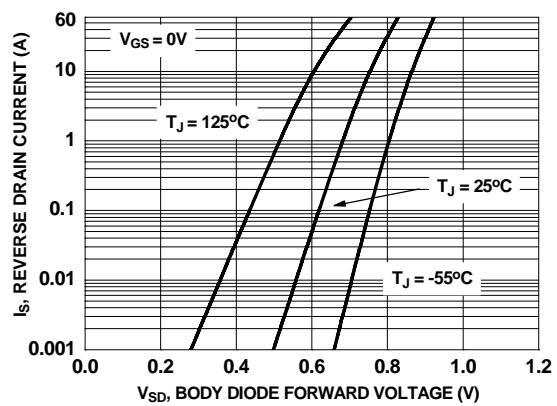

Figure 6. Source to Drain Diode Forward Voltage vs Source Current

Typical Characteristics $T_J = 25^\circ\text{C}$ unless otherwise noted

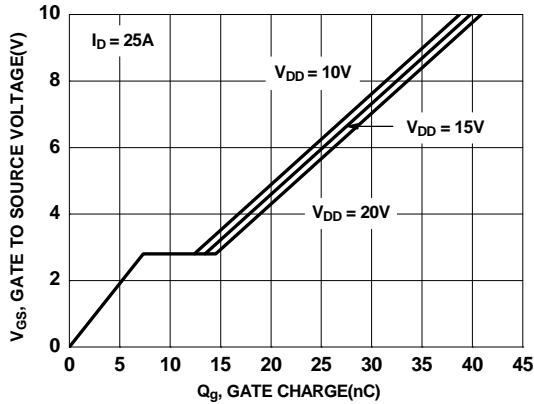

Figure 7. Gate Charge Characteristics

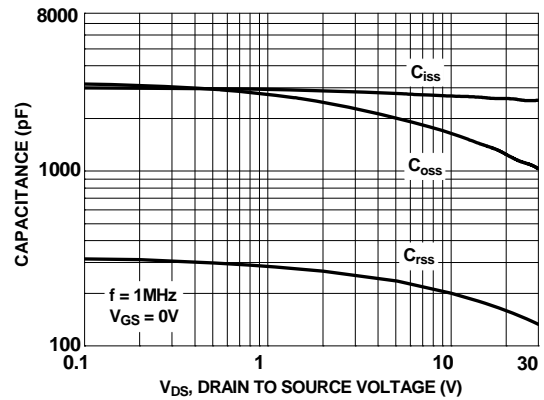

Figure 8. Capacitance vs Drain to Source Voltage

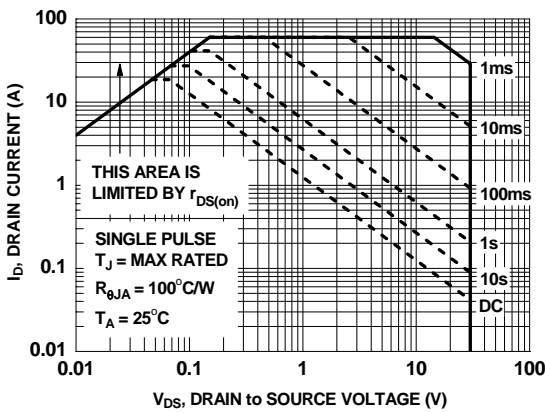

Figure 9. Forward Bias Safe Operating Area

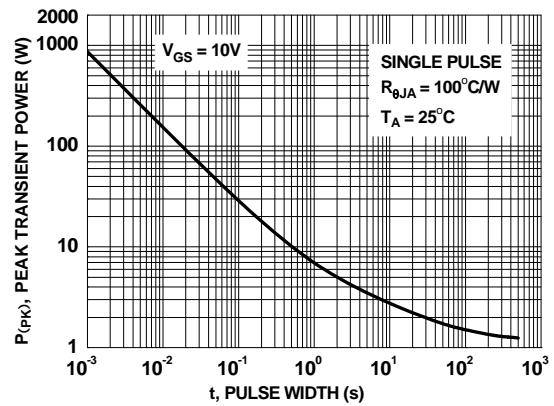

Figure 10. Single Pulse Maximum Power Dissipation

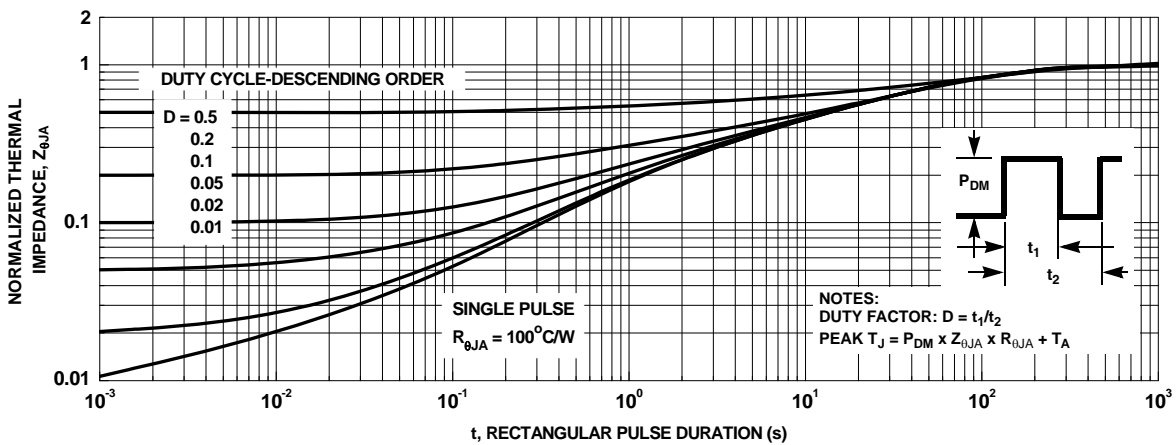
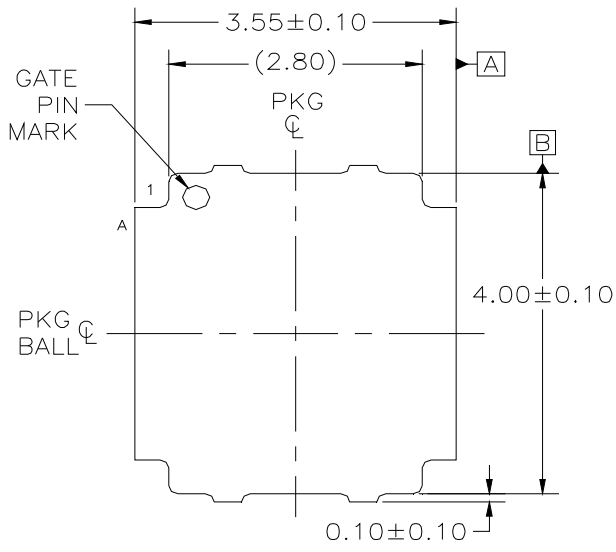
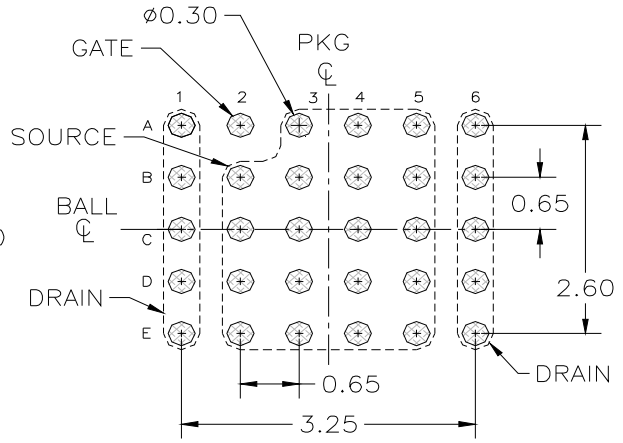

Figure 11. Transient Thermal Response Curve

Dimensional Outline and Pad Layout



TOP VIEW



LAND PATTERN RECOMMENDATION

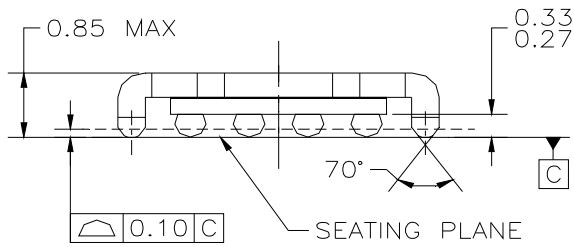

FRONT VIEW

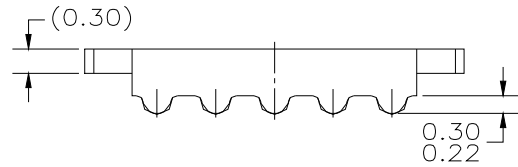

SIDE VIEW

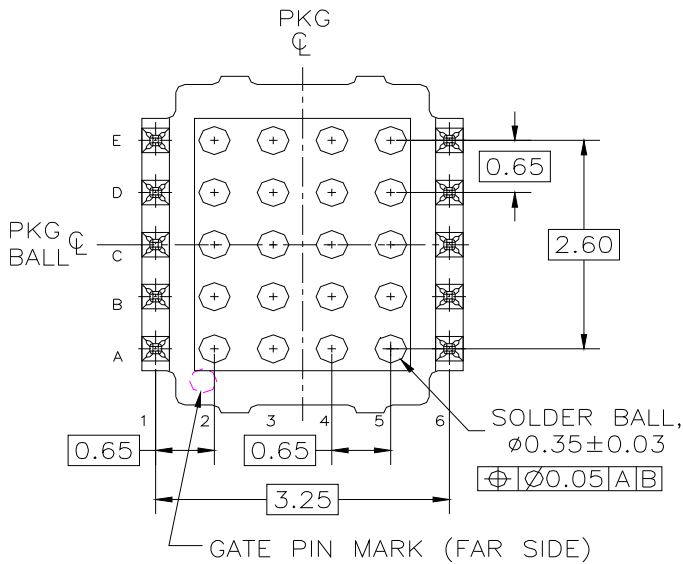

BOTTOM VIEW

- NOTES: UNLESS OTHERWISE SPECIFIED
 A) ALL DIMENSIONS ARE IN MILLIMETERS.
 B) NO JEDEC REGISTRATION REFERENCE AS OF MARCH 2006.
 C) TERMINAL CONFIGURATION TABLE

POSITION	DESIGNATION	TYPE
A1,B1,C1,D1,E1, A6,B6,C6,D6,E6	DRAIN	COPPER STUD
A2	GATE	SOLDER BALL
A3,A4,A5,B2,B3, B4,B5,C2,C3,C4, C5,D2,D3,D4,D5, E2,E3,E4,E5	SOURCE	SOLDER BALL

BGA020CREVA



TRADEMARKS

The following are registered and unregistered trademarks Fairchild Semiconductor owns or is authorized to use and is not intended to be an exhaustive list of all such trademarks.

ACEx®	HiSeC™	Power-SPM™	TinyBuck™
Across the board. Around the world™	<i>i-Lo</i> ™	PowerTrench®	TinyLogic®
ActiveArray™	ImpliedDisconnect™	Programmable Active Droop™	TINYOPTO™
Bottomless™	IntelliMAX™	QFET®	TinyPower™
Build it Now™	ISOPLANAR™	QS™	TinyWire™
CoolFET™	MICROCOUPLER™	QT Optoelectronics™	TruTranslation™
CorePLUS™	MicroPak™	Quiet Series™	µSerDes™
CROSSVOLT™	MICROWIRE™	RapidConfigure™	UHC®
CTL™	Motion-SPM™	RapidConnect™	UniFET™
Current Transfer Logic™	MSX™	ScalarPump™	VCX™
DOME™	MSXPro™	SMART START™	Wire™
E ² C MOS™	OCX™	SPM®	
EcoSPARK®	OCXPro™	STEALTH™	
EnSigna™	OPTOLOGIC®	SuperFET™	
FACT Quiet Series™	OPTOPLANAR®	SuperSOT™-3	
FACT®	PACMAN™	SuperSOT™-6	
FAST®	PDP-SPM™	SuperSOT™-8	
FASTr™	POP™	SyncFET™	
FPST™	Power220®	TCM™	
FRFET®	Power247®	The Power Franchise®	
GlobalOptoisolator™	PowerEdge™	 ™	
GTO™	PowerSaver™	TinyBoost™	

DISCLAIMER

FAIRCHILD SEMICONDUCTOR RESERVES THE RIGHT TO MAKE CHANGES WITHOUT FURTHER NOTICE TO ANY PRODUCTS HEREIN TO IMPROVE RELIABILITY, FUNCTION, OR DESIGN. FAIRCHILD DOES NOT ASSUME ANY LIABILITY ARISING OUT OF THE APPLICATION OR USE OF ANY PRODUCT OR CIRCUIT DESCRIBED HEREIN; NEITHER DOES IT CONVEY ANY LICENSE UNDER ITS PATENT RIGHTS, NOR THE RIGHTS OF OTHERS. THESE SPECIFICATIONS DO NOT EXPAND THE TERMS OF FAIRCHILD'S WORLDWIDE TERMS AND CONDITIONS, SPECIFICALLY THE WARRANTY THEREIN, WHICH COVERS THESE PRODUCTS.

LIFE SUPPORT POLICY

FAIRCHILD'S PRODUCTS ARE NOT AUTHORIZED FOR USE AS CRITICAL COMPONENTS IN LIFE SUPPORT DEVICES OR SYSTEMS WITHOUT THE EXPRESS WRITTEN APPROVAL OF FAIRCHILD SEMICONDUCTOR CORPORATION.

As used herein:

1. Life support devices or systems are devices or systems which, (a) are intended for surgical implant into the body or (b) support or sustain life, and (c) whose failure to perform when properly used in accordance with instructions for use provided in the labeling, can be reasonably expected to result in a significant injury of the user.

2. A critical component in any component of a life support, device, or system whose failure to perform can be reasonably expected to cause the failure of the life support device or system, or to affect its safety or effectiveness.

PRODUCT STATUS DEFINITIONS

Definition of Terms

Datasheet Identification	Product Status	Definition
Advance Information	Formative or In Design	This datasheet contains the design specifications for product development. Specifications may change in any manner without notice.
Preliminary	First Production	This datasheet contains preliminary data; supplementary data will be published at a later date. Fairchild Semiconductor reserves the right to make changes at any time without notice to improve design.
No Identification Needed	Full Production	This datasheet contains final specifications. Fairchild Semiconductor reserves the right to make changes at any time without notice to improve design.
Obsolete	Not In Production	This datasheet contains specifications on a product that has been discontinued by Fairchild Semiconductor. The datasheet is printed for reference information only.