

# FDFMA2P029Z

## Integrated P-Channel PowerTrench® MOSFET and Schottky Diode

-20V, -3.1A, 95mΩ

### Features

#### MOSFET

- Max  $r_{DS(on)}$  = 95mΩ at  $V_{GS} = -4.5V$ ,  $I_D = -3.1A$
- Max  $r_{DS(on)}$  = 141mΩ at  $V_{GS} = -2.5V$ ,  $I_D = -2.5A$
- HBM ESD protection level > 2.5kV (Note 3)

#### Schottky

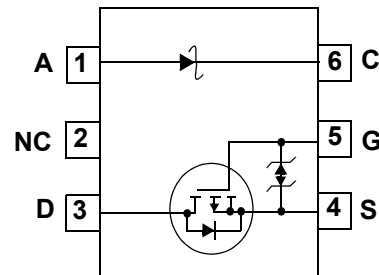
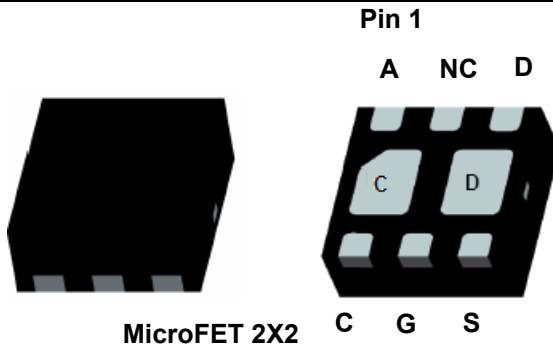
- $V_F < 0.37V$  @ 500mA
- Low profile - 0.8 mm maximum - in the new package MicroFET 2x2 mm
- RoHS Compliant



### General Description

This device is designed specifically as a single package solution for the battery charge switch in cellular handset and other ultra-portable applications. It features a MOSFET with very low on-state resistance and an independently connected low forward voltage schottky diode allows for minimum conduction losses.

The MicroFET 2X2 package offers exceptional thermal performance for its physical size and is well suited to linear mode applications.



### MOSFET Maximum Ratings $T_A = 25^\circ C$ unless otherwise noted

Symbol	Parameter	Rated	Units
$V_{DS}$	Drain to Source Voltage	-20	V
$V_{GS}$	Gate to Source Voltage	±12	V
$I_D$	Drain Current -Continuous (Note 1a)	-3.1	A
	-Pulsed	-6	
$P_D$	Power Dissipation (Note 1a)	1.4	W
		(Note 1b)	
$T_J, T_{STG}$	Operating and Storage Junction Temperature Range	-55 to +150	°C
$V_{RRM}$	Schottky Repetitive Peak Reverse Voltage	20	V
$I_O$	Schottky Average Forward Current	2	A

### Thermal Characteristics

$R_{\theta JA}$	Thermal Resistance, Junction to Ambient (Note 1a)	86	°C/W
$R_{\theta JA}$	Thermal Resistance, Junction to Ambient (Note 1b)	173	
$R_{\theta JA}$	Thermal Resistance, Junction to Ambient (Note 1c)	86	
$R_{\theta JA}$	Thermal Resistance, Junction to Ambient (Note 1d)	140	

### Package Marking and Ordering Information

Device Marking	Device	Package	Reel Size	Tape Width	Quantity
.P29	FDFMA2P029Z	MicroFET 2X2	7"	8mm	3000 units

## Electrical Characteristics $T_J = 25^\circ\text{C}$ unless otherwise noted

Symbol	Parameter	Test Conditions	Min	Typ	Max	Units
--------	-----------	-----------------	-----	-----	-----	-------

### Off Characteristics

$BV_{DSS}$	Drain to Source Breakdown Voltage	$I_D = -250\mu\text{A}, V_{GS} = 0\text{V}$	-20			V
$\frac{\Delta BV_{DSS}}{\Delta T_J}$	Breakdown Voltage Temperature Coefficient	$I_D = -250\mu\text{A}$ , referenced to $25^\circ\text{C}$		-12		mV/ $^\circ\text{C}$
$I_{DSS}$	Zero Gate Voltage Drain Current	$V_{DS} = -16\text{V}, V_{GS} = 0\text{V}$			-1	$\mu\text{A}$
$I_{GSS}$	Gate to Source Leakage Current	$V_{GS} = \pm 12\text{V}, V_{DS} = 0\text{V}$			$\pm 10$	$\mu\text{A}$

### On Characteristics

$V_{GS(th)}$	Gate to Source Threshold Voltage	$V_{GS} = V_{DS}, I_D = -250\mu\text{A}$	-0.6	-1.0	-1.5	V
$\frac{\Delta V_{GS(th)}}{\Delta T_J}$	Gate to Source Threshold Voltage Temperature Coefficient	$I_D = -250\mu\text{A}$ , referenced to $25^\circ\text{C}$		4		mV/ $^\circ\text{C}$
$r_{DS(on)}$	Static Drain to Source On-Resistance	$V_{GS} = -4.5\text{V}, I_D = -3.1\text{A}$		60	95	m $\Omega$
		$V_{GS} = -2.5\text{V}, I_D = -2.5\text{A}$		88	141	
		$V_{GS} = -4.5\text{V}, I_D = -3.1\text{A}, T_J = 125^\circ\text{C}$		87	140	
$g_{FS}$	Forward Transconductance	$V_{DS} = -10\text{V}, I_D = -3.1\text{A}$		-11		S

### Dynamic Characteristics

$C_{iss}$	Input Capacitance	$V_{DS} = -10\text{V}, V_{GS} = 0\text{V}, f = 1\text{MHz}$		540	720	pF
$C_{oss}$	Output Capacitance			120	160	pF
$C_{rss}$	Reverse Transfer Capacitance			100	150	pF

### Switching Characteristics

$t_{d(on)}$	Turn-On Delay Time	$V_{DD} = -10\text{V}, I_D = -1\text{A}, V_{GS} = -4.5\text{V}, R_{GEN} = 6\Omega$		13	24	ns
$t_r$	Rise Time			11	20	ns
$t_{d(off)}$	Turn-Off Delay Time			37	59	ns
$t_f$	Fall Time			36	58	ns
$Q_{g(TOT)}$	Total Gate Charge		$V_{DD} = -10\text{V}, I_D = -3.1\text{A}$		7	10
$Q_{gs}$	Gate to Source Gate Charge	$V_{GS} = -4.5\text{V}$		1.1		nC
$Q_{gd}$	Gate to Drain "Miller" Charge			2.4		nC

### Drain-Source Diode Characteristics

$I_S$	Maximum Continuous Drain-Source Diode Forward Current				-1.1	A
$V_{SD}$	Source to Drain Diode Forward Voltage	$V_{GS} = 0\text{V}, I_S = -1.1\text{A}$ (Note 2)		-0.8	-1.2	V
$t_{rr}$	Reverse Recovery Time	$I_F = -3.1\text{A}, di/dt = 100\text{A}/\mu\text{s}$		25		ns
$Q_{rr}$	Reverse Recovery Charge			9		nC

### Schottky Diode Characteristics

$V_R$	Reverse Voltage	$I_R = 1\text{mA}$	$T_J = 25^\circ\text{C}$	20			V
$I_R$	Reverse Leakage	$V_R = 20\text{V}$	$T_J = 25^\circ\text{C}$		30	300	$\mu\text{A}$
			$T_J = 125^\circ\text{C}$		10	45	mA
$V_F$	Forward Voltage	$I_F = 500\text{mA}$	$T_J = 25^\circ\text{C}$		0.32	0.37	V
			$T_J = 125^\circ\text{C}$		0.21	0.26	
		$I_F = 1\text{A}$	$T_J = 25^\circ\text{C}$		0.37	0.435	
			$T_J = 125^\circ\text{C}$		0.28	0.33	

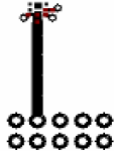
**Notes:**

1:  $R_{\theta JA}$  is determined with the device mounted on a 1 in<sup>2</sup> oz. copper pad on a 1.5 x 1.5 in. board of FR-4 material.  $R_{\theta JC}$  is guaranteed by design while  $R_{\theta JA}$  is determined by the user's board design.

- (a) MOSFET  $R_{\theta JA} = 86^{\circ}\text{C/W}$  when mounted on a 1in<sup>2</sup> pad of 2 oz copper, 1.5" x 1.5" x 0.062" thick PCB
- (b) MOSFET  $R_{\theta JA} = 173^{\circ}\text{C/W}$  when mounted on a minimum pad of 2 oz copper
- (c) Schottky  $R_{\theta JA} = 86^{\circ}\text{C/W}$  when mounted on a 1in<sup>2</sup> pad of 2 oz copper, 1.5" x 1.5" x 0.062" thick PCB.
- (d) Schottky  $R_{\theta JA} = 140^{\circ}\text{C/W}$  when mounted on a minimum pad of 2 oz copper.



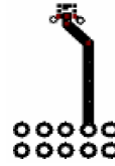
a)  $86^{\circ}\text{C/W}$  when mounted on a 1in<sup>2</sup> pad of 2 oz copper.



b)  $173^{\circ}\text{C/W}$  when mounted on a minimum pad of 2 oz copper.



c)  $86^{\circ}\text{C/W}$  when mounted on a 1in<sup>2</sup> pad of 2 oz copper.

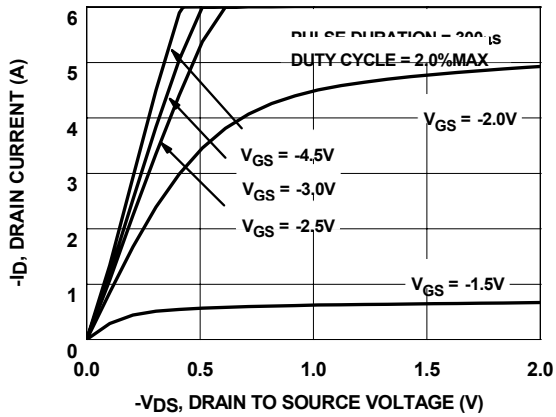


d)  $140^{\circ}\text{C/W}$  when mounted on a minimum pad of 2 oz copper.

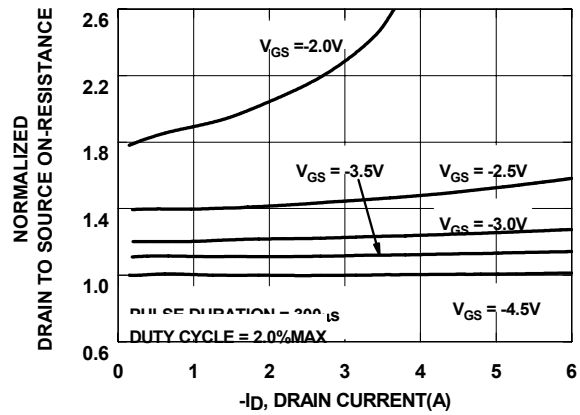
2: Pulse Test : Pulse Width < 300us, Duty Cycle < 2.0%

3. The diode connected between the gate and source serves only protection against ESD. No gate overvoltage rating is implied.

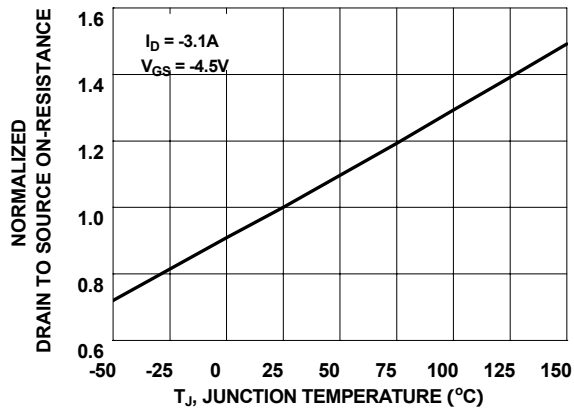
**Typical Characteristics**  $T_J = 25^\circ\text{C}$  unless otherwise noted



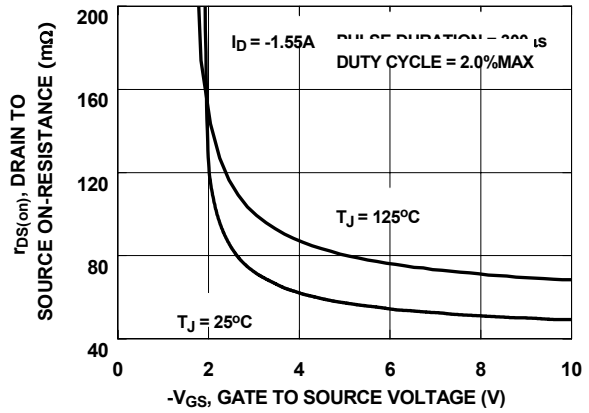
**Figure 1. On Region Characteristics**



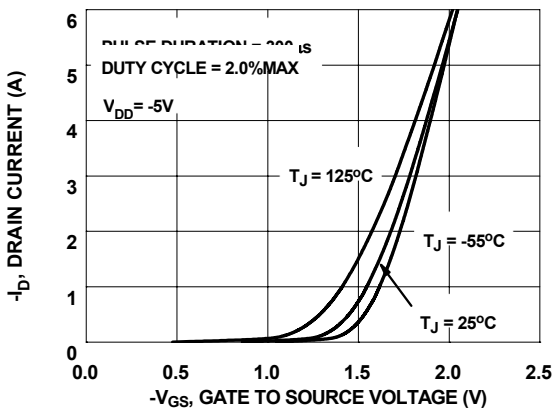
**Figure 2. Normalized On-Resistance vs Drain Current and Gate Voltage**



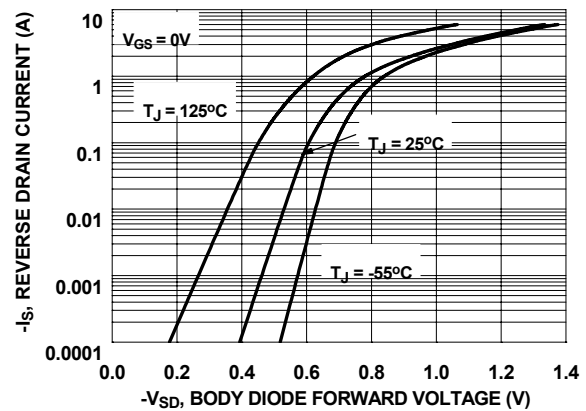
**Figure 3. Normalized On-Resistance vs Junction Temperature**



**Figure 4. On-Resistance vs Gate to Source Voltage**

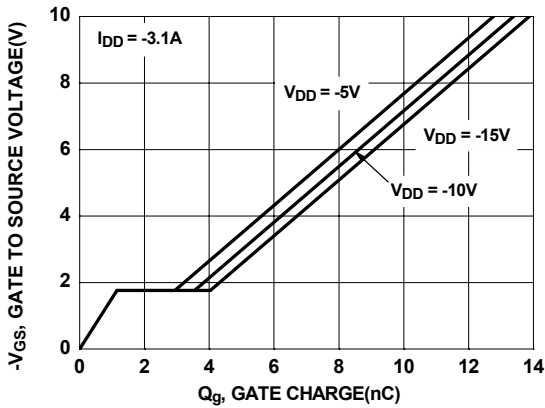


**Figure 5. Transfer Characteristics**

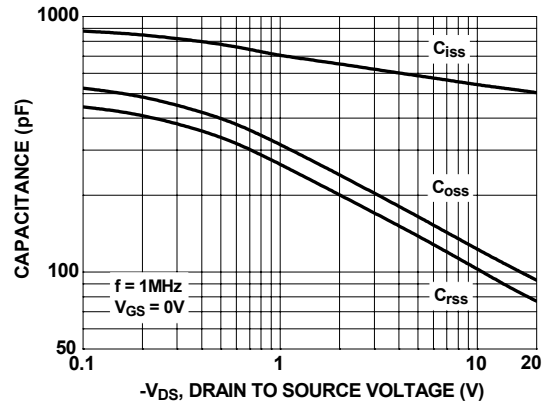


**Figure 6. Source to Drain Diode Forward Voltage vs Source Current**

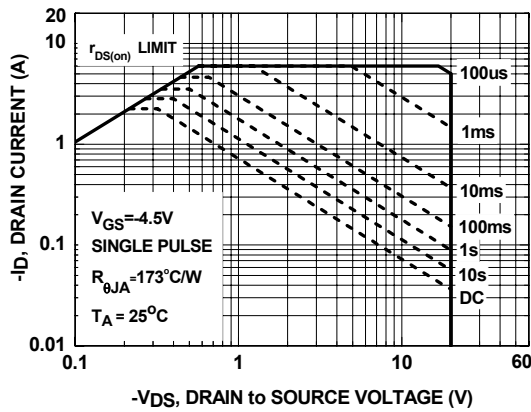
**Typical Characteristics**  $T_J = 25^\circ\text{C}$  unless otherwise noted



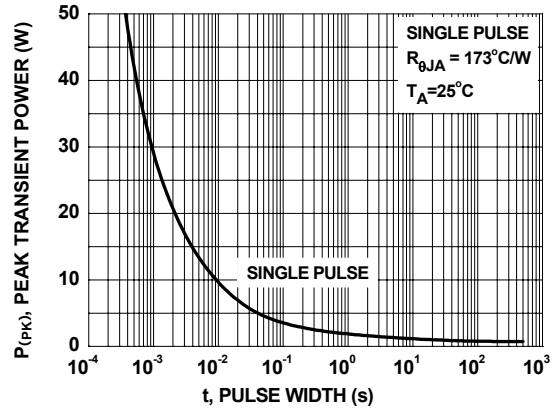
**Figure 7. Gate Charge Characteristics**



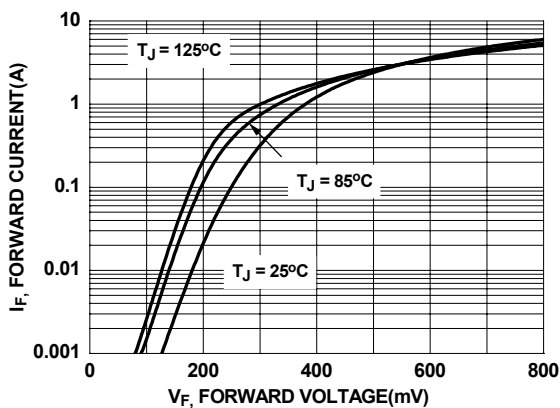
**Figure 8. Capacitance Characteristics**



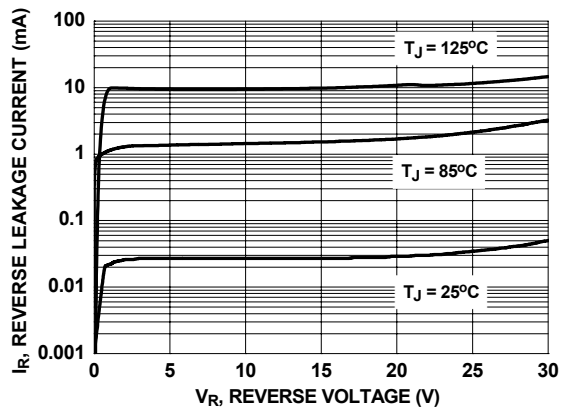
**Figure 9. Forward Bias Safe Operating Area**



**Figure 10. Single Pulse Maximum Power Dissipation**

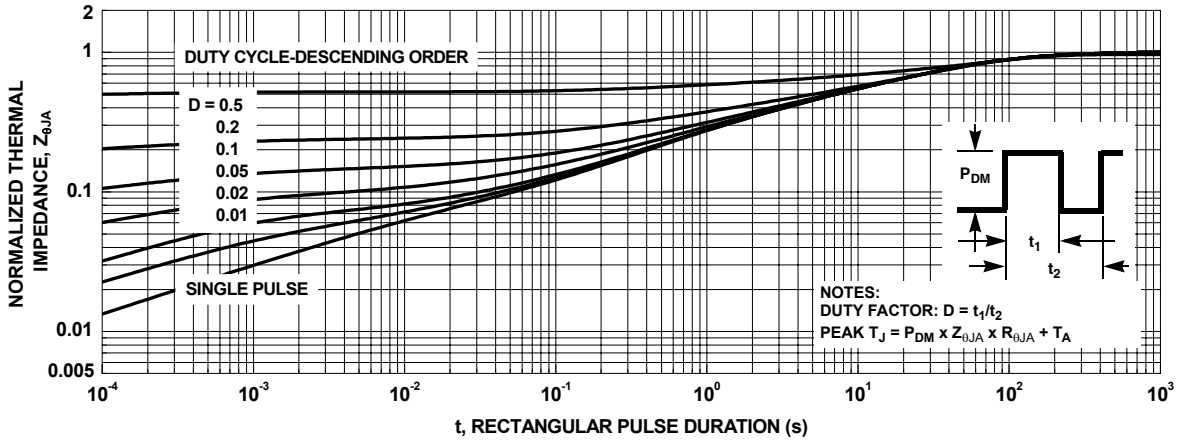


**Figure 11. Schottky Diode Forward Voltage**

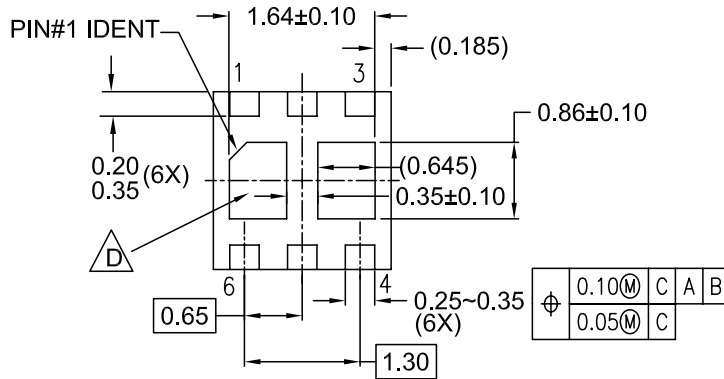
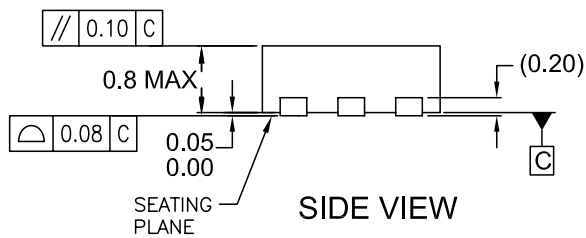
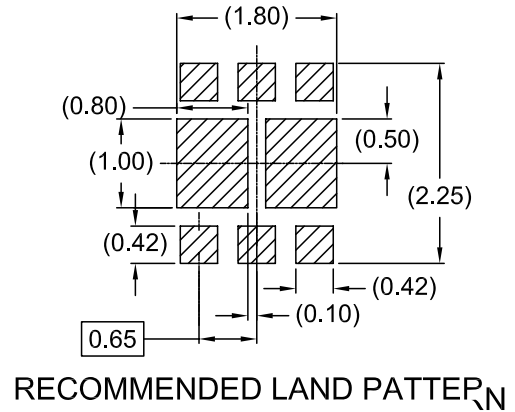
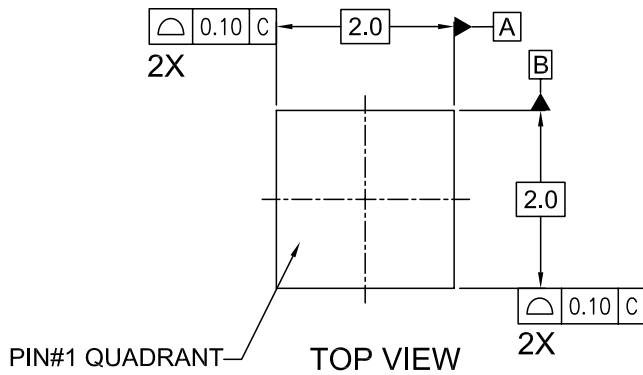


**Figure 12. Schottky Diode Reverse Current**

**Typical Characteristics**  $T_J = 25^\circ\text{C}$  unless otherwise noted



### Dimensional Outline and Pad Layout








#### NOTES:

- A. CONFORMS TO JEDEC REGISTRATION MO-229, VARIATION VCCC EXCEPT AS NOTED.
- B. DIMENSIONS ARE IN MILLIMETERS.
- C. DIMENSIONS AND TOLERANCES PER ASME Y14.5M, 1994
- D. NON-JEDEC DUAL DAP
- E. DRAWING FILE NAME : MLP06Jrev3



**TRADEMARKS**

The following includes registered and unregistered trademarks and service marks, owned by Fairchild Semiconductor and/or its global subsidiaries, and is not intended to be an exhaustive list of all such trademarks.

- |   |   |   |   |
|---|---|---|---|
| ACEx <sup>®</sup>   | FPS <sup>™</sup>  | PDP-SPM <sup>™</sup>  | The Power Franchise <sup>®</sup>  |
| Build it Now <sup>™</sup>   | F-PFS <sup>™</sup>  | Power-SPM <sup>™</sup>  | <b>the power</b><br>franchise   |
| CorePLUS <sup>™</sup>   | FRFET <sup>®</sup>  | PowerTrench <sup>®</sup>  | TinyBoost <sup>™</sup>  |
| CorePOWER <sup>™</sup>  | Global Power Resource <sup>SM</sup>   | Programmable Active Droop <sup>™</sup>  | TinyBuck <sup>™</sup>   |
| CROSSVOLT <sup>™</sup>  | Green FPS <sup>™</sup>  | QFET <sup>®</sup>   | TinyLogic <sup>®</sup>  |
| CTL <sup>™</sup>  | Green FPS <sup>™</sup> e-Series <sup>™</sup>                                      | QS <sup>™</sup>   | TINYOPTO <sup>™</sup>   |
| Current Transfer Logic <sup>™</sup>   | GTO <sup>™</sup>  | Quiet Series <sup>™</sup>   | TinyPower <sup>™</sup>  |
| EcoSPARK <sup>®</sup>   | IntelliMAX <sup>™</sup>   | RapidConfigure <sup>™</sup>   | TinyPWM <sup>™</sup>  |
| EfficientMax <sup>™</sup>   | ISOPLANAR <sup>™</sup>  | Saving our world 1mW at a time <sup>™</sup>                                       | TinyWire <sup>™</sup>   |
| EZSWITCH <sup>™</sup> *   | MegaBuck <sup>™</sup>   | SmartMax <sup>™</sup>   | μSerDes <sup>™</sup>  |
|  | MICROCOUPLER <sup>™</sup>   | SMART START <sup>™</sup>  |  |
|  | MicroFET <sup>™</sup>   | SPM <sup>®</sup>  | UHC <sup>®</sup>  |
| Fairchild <sup>®</sup>  | MicroPak <sup>™</sup>   | STEALTH <sup>™</sup>  | Ultra FRFET <sup>™</sup>  |
| Fairchild Semiconductor <sup>®</sup>  | MillerDrive <sup>™</sup>  | SuperFET <sup>™</sup>   | UniFET <sup>™</sup>   |
| FACT Quiet Series <sup>™</sup>  | MotionMax <sup>™</sup>  | SuperSOT <sup>™</sup> -3  | VCX <sup>™</sup>  |
| FACT <sup>®</sup>   | Motion-SPM <sup>™</sup>   | SuperSOT <sup>™</sup> -6  | VisualMax <sup>™</sup>  |
| FAST <sup>®</sup>   | OPTOLOGIC <sup>®</sup>  | SuperSOT <sup>™</sup> -8  |   |
| FastvCore <sup>™</sup>  | OPTOPLANAR <sup>®</sup>   | SuperMOS <sup>™</sup>   |   |
| FlashWriter <sup>®</sup> *  |  |  |   |

\* EZSWITCH<sup>™</sup> and FlashWriter<sup>®</sup> are trademarks of System General Corporation, used under license by Fairchild Semiconductor.

**DISCLAIMER**

FAIRCHILD SEMICONDUCTOR RESERVES THE RIGHT TO MAKE CHANGES WITHOUT FURTHER NOTICE TO ANY PRODUCTS HEREIN TO IMPROVE RELIABILITY, FUNCTION, OR DESIGN. FAIRCHILD DOES NOT ASSUME ANY LIABILITY ARISING OUT OF THE APPLICATION OR USE OF ANY PRODUCT OR CIRCUIT DESCRIBED HEREIN; NEITHER DOES IT CONVEY ANY LICENSE UNDER ITS PATENT RIGHTS, NOR THE RIGHTS OF OTHERS. THESE SPECIFICATIONS DO NOT EXPAND THE TERMS OF FAIRCHILD'S WORLDWIDE TERMS AND CONDITIONS, SPECIFICALLY THE WARRANTY THEREIN, WHICH COVERS THESE PRODUCTS.

**LIFE SUPPORT POLICY**

FAIRCHILD'S PRODUCTS ARE NOT AUTHORIZED FOR USE AS CRITICAL COMPONENTS IN LIFE SUPPORT DEVICES OR SYSTEMS WITHOUT THE EXPRESS WRITTEN APPROVAL OF FAIRCHILD SEMICONDUCTOR CORPORATION.

As used herein:

- Life support devices or systems are devices or systems which, (a) are intended for surgical implant into the body or (b) support or sustain life, and (c) whose failure to perform when properly used in accordance with instructions for use provided in the labeling, can be reasonably expected to result in a significant injury of the user.
- A critical component in any component of a life support, device, or system whose failure to perform can be reasonably expected to cause the failure of the life support device or system, or to affect its safety or effectiveness.

**PRODUCT STATUS DEFINITIONS**

**Definition of Terms**

Datasheet Identification	Product Status	Definition
Advance Information	Formative or In Design	This datasheet contains the design specifications for product development. Specifications may change in any manner without notice.
Preliminary	First Production	This datasheet contains preliminary data; supplementary data will be published at a later date. Fairchild Semiconductor reserves the right to make changes at any time without notice to improve design.
No Identification Needed	Full Production	This datasheet contains final specifications. Fairchild Semiconductor reserves the right to make changes at any time without notice to improve the design.
Obsolete	Not In Production	This datasheet contains specifications on a product that is discontinued by Fairchild Semiconductor. The datasheet is for reference information only.

Rev. I34